



Diagnostic Procedures Manual

Section III

DIAGNOSTIC TESTING

Temp. °F	70	50	30	15	0
Min. Volts	9.6	9.4	9.1	8.8	8.5

e. If recorded voltage does not meet or exceed that in table, replace battery. Otherwise battery is OK.

3-1. TESTING FREEDOM BATTERIES

CAUTION
When handling batteries, wear face or eye protection and provide good ventilation. Have a water supply available and keep away from fire, flame or sparks.

3-2. TEST PROCEDURE.

Disconnect

NOTICE
If battery has threaded terminals, use terminal adapters, AC-Delco No. ST-1201, on each terminal when testing or charging.

Inspect

1. Each battery visually for damage.
2. Battery hydrometer eye.
 - If battery has no hydrometer eye, proceed to step 3.
 - Eye shows green, proceed to step 3.
 - Eye shows dark, recharge battery then proceed to step 3.
 - Eye shows yellow, replace battery.
3. Apply 300 amp load to battery for 15 seconds and turn off load. Wait one minute.
4. If battery has no hydrometer eye, measure terminal voltage.

3-3. TEST COMPLETION.

Clean

1. Cable ends and battery terminals with wire brush.

Tighten

1. Battery hold-downs to specifications.

NOTICE
Leave battery cables disconnected and proceed with wiring tests.

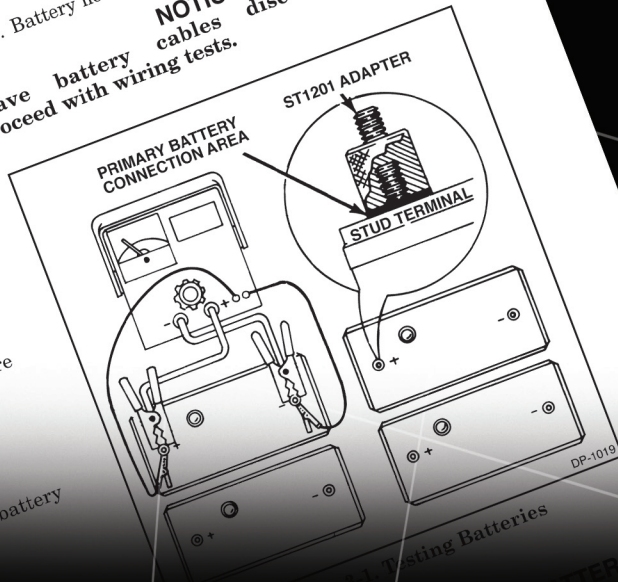

If more, continue test.
If more, recharge battery

Testing Batteries

BATTERIES

CONTENTS

Section		Page
I	INTRODUCTION AND DESCRIPTION	
	1-1. Introduction	1-1
	1-7. Description	1-1
	1-12. Electrical Fundamentals	1-2
II	DIAGNOSIS CHARTS	
	2-1. Overcharge Symptoms	2-1
	2-2. Undercharge Symptoms	2-2
	2-3. Milled Pinion Symptoms	2-3
III	TESTING	
	3-1. Testing Freedom Batteries	3-1
	3-4. Testing Conventional Batteries	3-1
	3-5. Test Procedure	3-2
	3-7. Battery Cable Test with Single Battery Location	3-2
	3-10. Battery Cable Test with Dual-Battery Locations	3-3
	3-13. Starter Solenoid Circuit Test	3-4
	3-18. Magnetic Switch Circuit Test	3-6
	3-21. Starter Replacement Determination	3-6
	3-26. Alternator Wiring Test	3-7
	3-29. Alternator Replacement Determination	3-8
	3-33. Completion of All Tests	3-9
IV	SUMMARY	4-1
V	APPENDIX	
	5-1. Overcrank Protection (OCP) Circuit Check	5-1
	5-2. Multi-Battery Charging with Series Parallel Chargers	5-1
	5-3. Group Charging on Current-Limiting or Series Chargers	5-2
	5-4. Group Charging on Voltage-Limited or Parallel Chargers	5-2
	5-5. Heavy Duty Diagnostics Procedures Data	5-3

Section I

INTRODUCTION AND DESCRIPTION

1-1. INTRODUCTION

1-2. PURPOSE. The purpose of this manual is to provide diagnostic procedures that can be used for troubleshooting a heavy-duty electrical system, consisting of the starting system and the charging system. Some of the procedures described in this manual may also be used for preventative maintenance checks. These procedures are applicable to systems using Heavy Duty Starters such as: Delco Remy 37 MT, 41 MT, 42 MT, 50 MT or similar with adequate battery power for the engine/starter application used.

1-3. DEFINITION OF "DIAGNOSIS." Diagnosis is the three part process that begins when a problem is perceived and ends when the equipment is confirmed as serviceable. The process can be described by using three questions that must be answered to assure completion:

1. What are the symptoms? This is what has been observed (seen, heard, felt or smelled) that indicates a problem.

2. What caused the symptoms? This involves using diagnostic procedures to identify the root cause of the problem.

3. How do we fix it? Usually this involves the adjustment, repair or replacement of some part or parts.

1-4. The primary emphasis of this manual is to define the procedures to determine "what caused the symptoms." Actual adjustment, repair or replacement procedures are provided in unit specific service bulletins and manuals.

1-5. For educational purposes, study of this entire manual is recommended. For diagnostic purposes, the flow charts in Section II will reference appropriate procedures for specific symptoms.

1-6. EQUIPMENT REQUIRED. To perform the tests specified in this manual, the following equipment is required:

1. A variable carbon pile load tester, more than 500 amps capacity with ammeter (and voltmeter).

2. A separate DC voltmeter, digital preferred, capable of reading 0.01 volt increments.

3. An inductive (clamp-on) ammeter for safe and accurate current measurements.

1-7. DESCRIPTION

1-8. SYSTEM. The heavy-duty electrical system is made up of the starting system and the charging system. These systems are, in turn, comprised of batteries, the starter, the alternator, the interconnecting wiring and electrical and mechanical switches. For maximum operating efficiency, *all* parts of the system must be functioning properly.

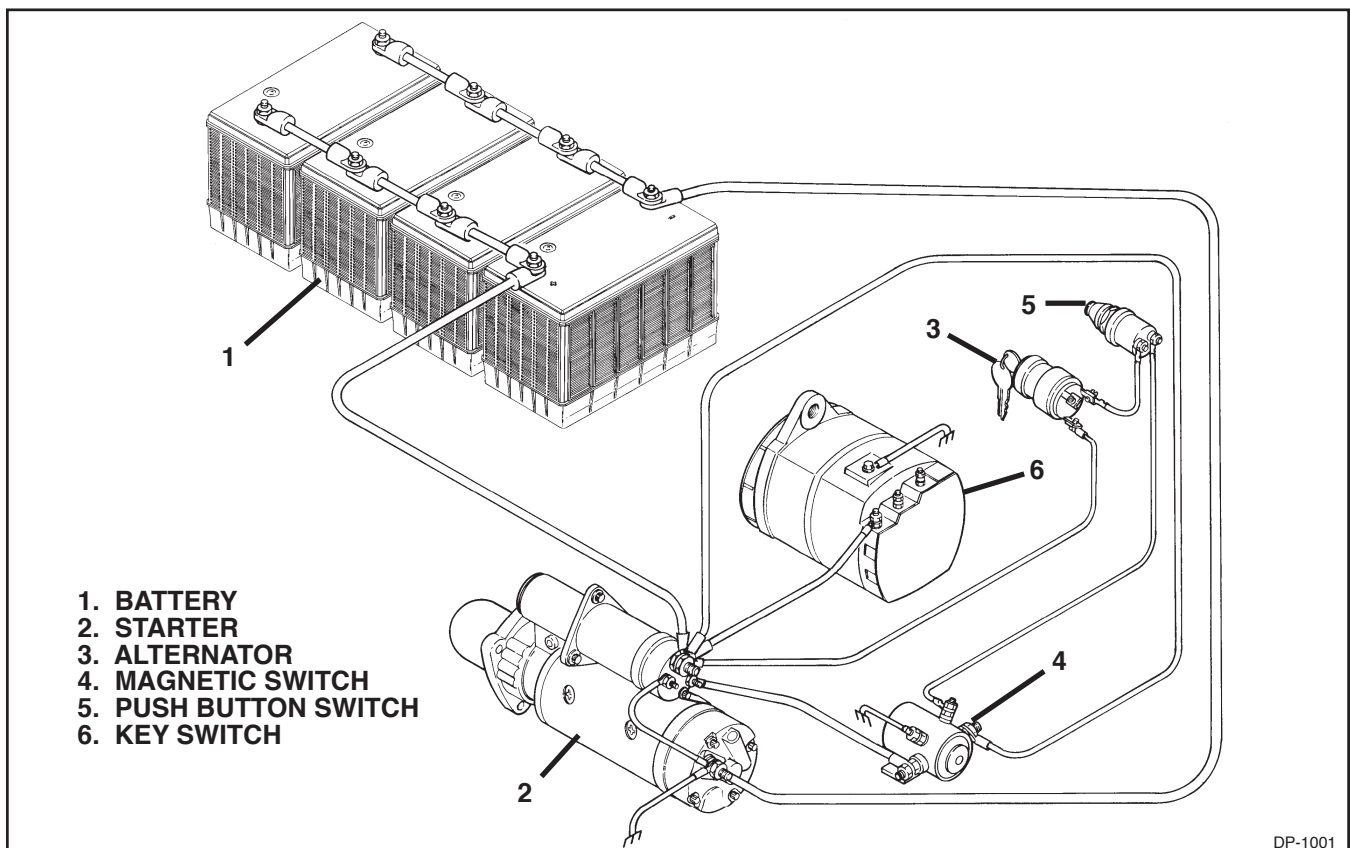

Figure 1-1. Heavy Duty Electrical System

1-9. BATTERIES. Batteries are perishable devices that wear out at some point in time. With use they deteriorate and eventually become incapable of performing their important job. In addition, new, good batteries may become discharged for various reasons. Neither worn out nor discharged batteries can supply the power necessary for cranking. Thus the battery check becomes the starting point for diagnosing electrical system problems.

1-10. SUB-CIRCUITS. (See Figure 1-1) Because of vibration, corrosion, temperature changes or damage, the performance of wiring, connections, and secondary components as well as the function of the starter and alternator can deteriorate. This in turn can cause malfunctions within the starting and charging systems. For the purpose of testing, wiring and components are broken down into four circuits that must be tested. These are:

1. Cranking Circuit. This consists of the large cables that carry the high starter current. Excessive loss here causes slow cranking speeds, especially in cold weather. Inability to start from slow cranking can lead to starter burn-up if the starter is cranked over 30 seconds. Deeply discharged or worn-out batteries can also cause the same problem.

2. Solenoid Circuit. This consists of the wiring from the battery, through a push button or magnetic switch, to the "S" terminal of the starter solenoid, and back to the battery. Excessive loss here can cause the solenoid to shift in and out (chatter) resulting in a no-start condition. This can cause a burned contact disc and terminals of the starter solenoid. Deeply discharged batteries can also cause this problem.

3. Magnetic Switch Circuit (When Magnetic Switch Used). This is made up of the wiring from the battery through a key switch and/or start button to the coil of the magnetic switch and back to the battery. Excessive loss here can cause a "no start" complaint.

4. Charging Circuit. This consists of the wiring between the alternator and the battery and back to the alternator. Excessive loss here can cause the batteries to not charge properly. As noted above, discharged batteries will cause other problems.

1-11. SEQUENCE OF PROCEDURES. It is important that the procedures in the manual be followed in the exact sequence specified. Batteries, wiring and connections should be checked and corrected to the specifications given. If cranking problems still occur, then connecting cables should be checked before replacing the starter with a known good unit. Similarly, in the charging circuit, batteries wiring and connections should be thoroughly checked and corrected to the specifications given. Only then should the alternator be checked and replaced if necessary.

1-12. ELECTRICAL FUNDAMENTALS

1-13. TERMS AND DEFINITIONS. Following are some electrical terms that we will be dealing with in this manual and their definitions:

1. Voltage (See Figure 1-2). Voltage is the electrical pressure or force that causes current or electrons to flow through a conductor. The voltage can also be described as the difference in electrical pressure between two points in a circuit. This electrical force or pressure is measured in volts.

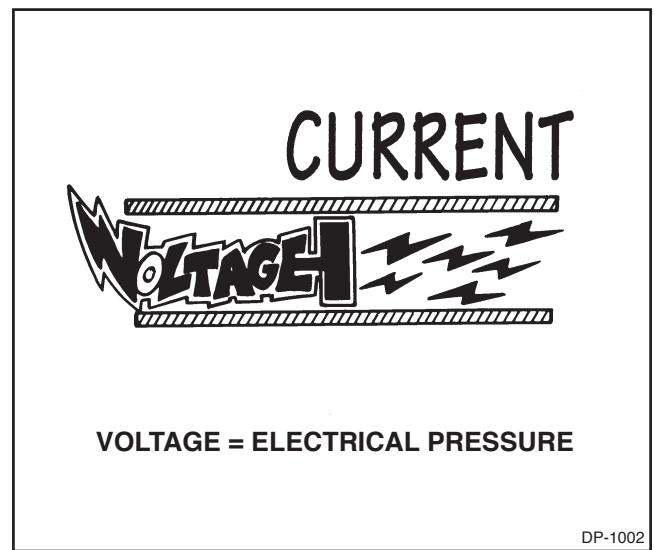

Figure 1-2. Voltage

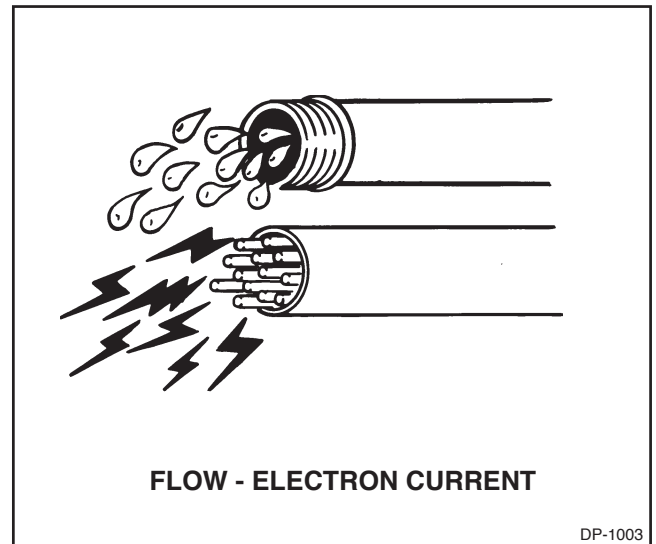

Figure 1-3. Current

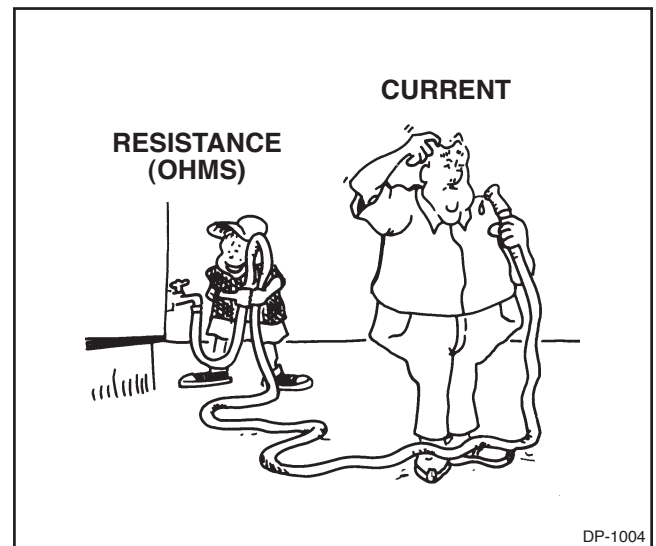
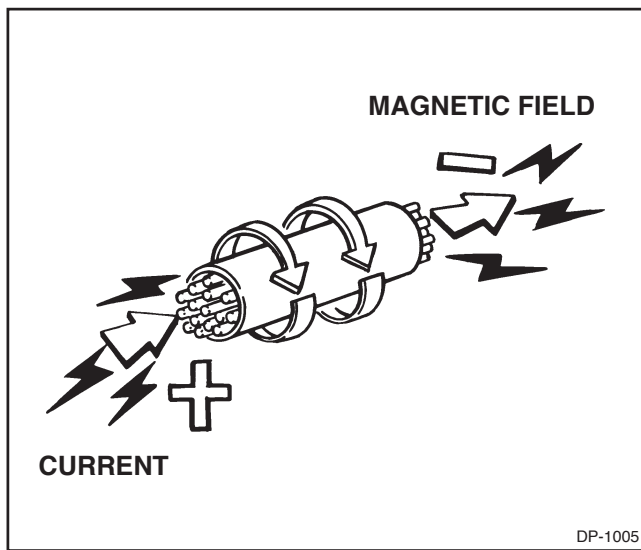

Figure 1-4. Resistance

2. Current (See Figure 1-3). Electrical current is the flow or movement of electrons in a conductor. This movement can be compared to the flow of water through a pipe. Without pressure (voltage) the current will not flow. Electrical flow is measured in amperes, most often abbreviated as amps.



3. Resistance (See Figure 1-4). Resistance is the opposition to current flow. For a given electrical pressure (voltage), resistance decreases current flow. This can be detected by voltage loss or drops in the electrical circuit. Electrical resistance is measured in ohms.

4. Magnetic Field (See Figure 1-5). When electrical current flows through a conductor, a magnetic field is produced around the conductor. By measuring the strength of this magnetic field it is possible to determine the amount of the current flow or amperage. This principal is the basis for the function of the clamp-on or induction type ammeter.

1-14. MEASURING VOLTAGE WITH THE VOLTMETER. The voltmeter is used to measure electrical pressure or voltage. The unit of measure is the volt. Voltmeters are always connected across (in parallel with) a part of the electrical circuit (See Figures 1-6 and 1-7). The voltmeter measures the difference in electrical potential or pressure between the points where the voltmeter is attached.

1-15. VOLTMETER SELECTION. Voltmeters for the purposes described in this manual are DC instruments with a range as follows:

1. Low scale: 0-3 volts
2. 12 volt vehicles: 0-16 volts
3. 24 volt vehicles: 0-32 volts

NOTE

The use of digital voltmeters is highly recommended for the following reasons:

- Digital voltmeters are generally more accurate than analog (needle movement) instruments.
- Digital readings need no interpretation; everyone sees the same number.
- Digital instruments are generally autoranging; they automatically select the proper range for the value of the reading.
- Reversing polarity with a digital instrument will simply result in a negative reading (minus sign) whereas with an analog voltmeter, reversing polarity could damage the meter.
- If analog meters are not read directly facing the meter, inaccuracies may result.

1-16. VOLTMETER USE. Figures 1-6 through 1-8 illustrate the proper use of the voltmeter and the types of readings that can be expected.

1. Figure 1-6 shows the voltmeter being used with no current flow, that is with the starter not operating.

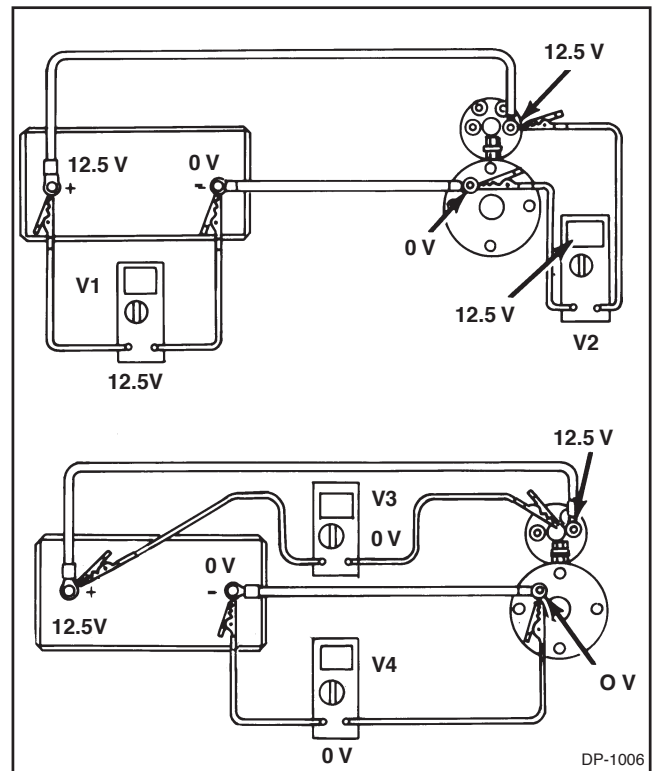

Figure 1-6. Voltmeter Readings With No Current Flow

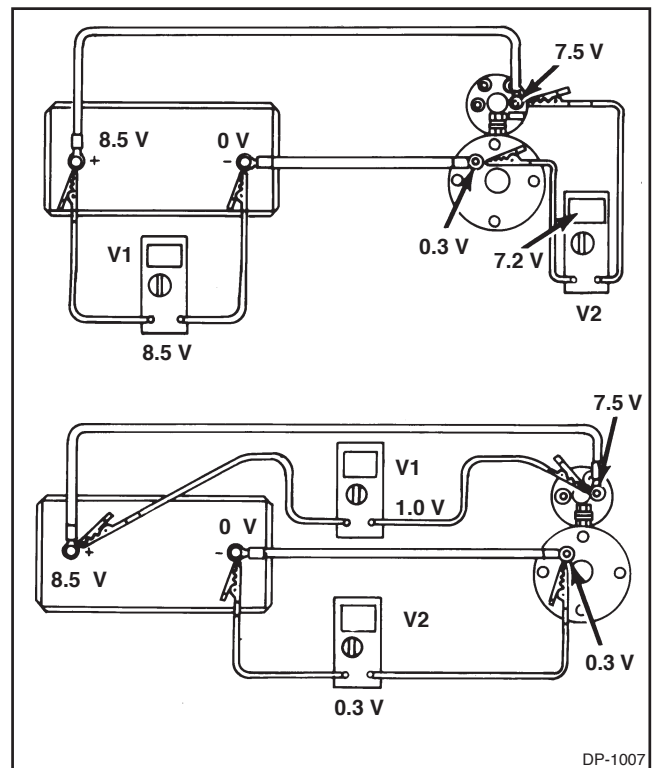

Figure 1-7. Voltmeter Readings With Current Flow

NOTE

When the voltmeter is connected in parallel with a cable (meter leads and cable ends start and end at the same point), the meter will measure the voltage potential at both ends of the cable. With no current flowing, the values will always be the same. Thus the voltmeter will read zero.

2. Figure 1-7 shows the voltmeter being used with current flow (starter pulling 500 amps).

NOTE

The V1 reading (See Figure 1-7) means that with 500 amps flowing through the positive cable there is a 1.0 volt drop in that cable. There must be current flow in order to produce a voltage drop. The V2 reading (See Figure 1-7) of 0.3 volt means that with 500 amps flowing through the negative cable there is a 0.3 volt drop in the negative cable.

3. Figure 1-8 illustrates the digital voltmeter reading in a DC system with both correct and incorrect polarity. Whenever the minus sign is read, reverse the meter leads to obtain the correct polarity.

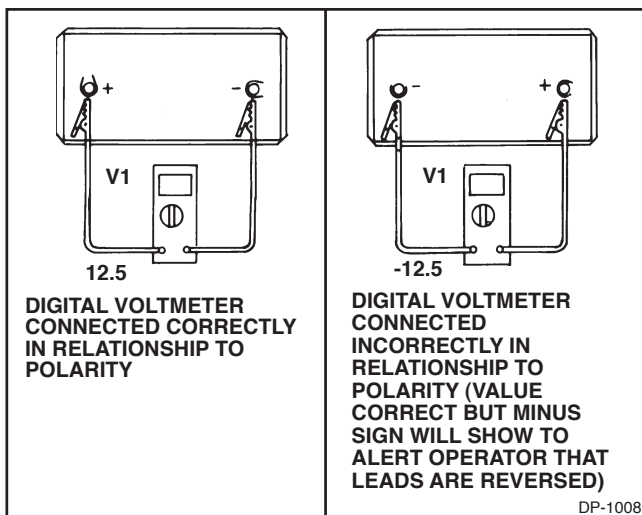

Figure 1-8. Correct and Incorrect Polarity Readings

1-17. MEASURING CURRENT FLOW WITH THE AMMETER. The ammeter is used to measure current flow. The unit of measure is the ampere or amp. Unless the induction pickup (clamp-on) ammeter is used, the circuit must be opened and the ammeter connected in series in order to take measurements.

1-18. AMMETER SELECTION. With but few exceptions (See Figure 1-10) it is desirable to make ammeter readings without opening up the circuit and thus disturbing a circuit defect and prevent it from being discovered. Therefore the use of a clamp-on induction type ammeter is recommended for most of the measurements described in this manual. This type is easy to use, cannot be damaged by misconnection and will not damage the vehicle wiring. A clamp-on ammeter operates by measuring the magnetic flux produced by current flow through a conductor and translating that into amperes which are displayed on the meter readout.

1-19. AMMETER USE. Figures 1-9 through 1-11 illustrate the use of various types of ammeters.

1. Figure 1-9 illustrates the use of an in-line digital ammeter. Note that the circuit must be disconnected in order to use this type of meter. The unit shown is an internal shunt type and generally used for loads of 10 amps or less. Care must be taken not to measure current greater than the meter rating. This type of ammeter is not recommended for most of the measurements described in this manual. However, if this is the only type available, be sure to follow the meter manufacturer's instructions for connection and use.

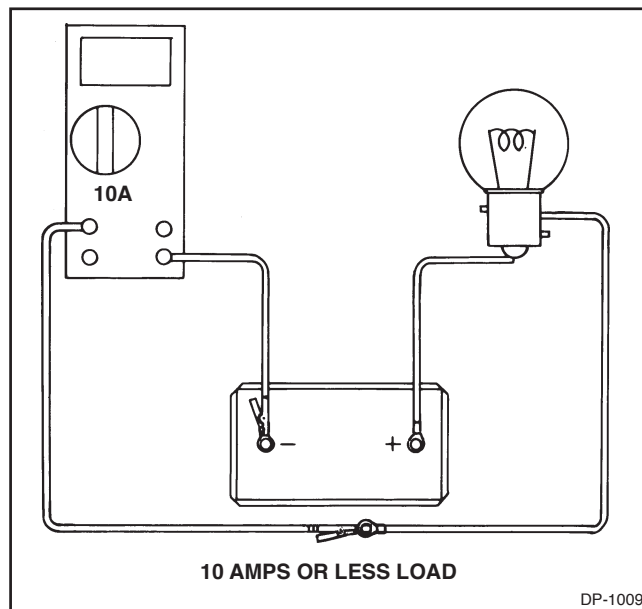

Figure 1-9. In-Line Digital Ammeter

2. Figure 1-10 shows an in-line digital ammeter used to measure an unknown current draw such as may result from a parasitic load. On the 10 amp scale the current would be too low to be measurable. However, with the meter on the 300 ma scale, the current draw in milliamps can be read.

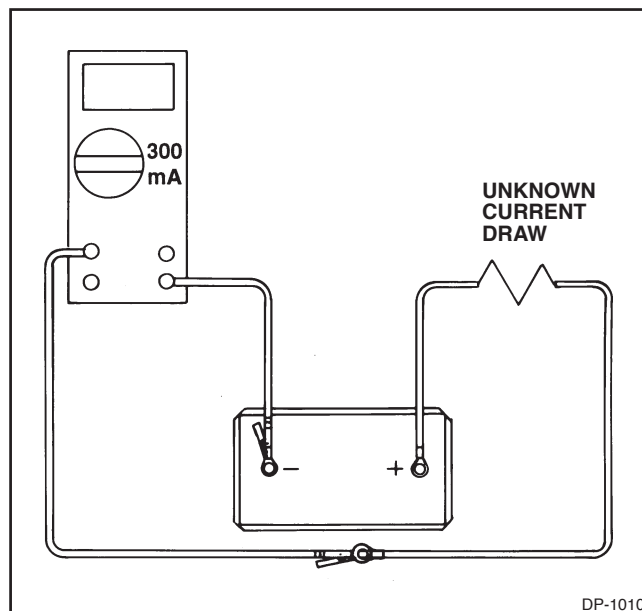

Figure 1-10. In-Line Ammeter

3. Figure 1-11 shows a clamp-on ammeter, the most common type of current measurement described in this manual. Be sure to zero out the meter before using and make sure the jaws are completely closed during use. Place the meter jaws around the cable, with the arrow points in the direction of current flow, to measure all the current.

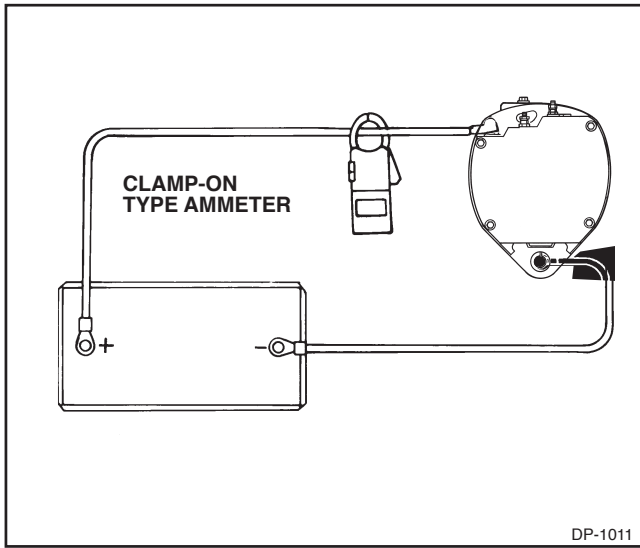

Figure 1-11. Clamp-On Type Ammeter

1-20. MEASURING RESISTANCE WITH THE OHMMETER. The ohmmeter is used to measure electrical resistance. The unit of measure is the ohm. The ohmmeter is connected across the unit or portion of the circuit for which the resistance is to be measured. The ohmmeter has its own power source, usually a small battery, which causes current to flow through the circuit to be measured. Since the meter power source (battery) voltage is known, the current is inversely proportional to the resistance of the circuit. The meter automatically computes and reads out the resistance: E (voltage) divided by I (current) equals R (resistance).

1-21. OHMMETER SELECTION. As with voltmeters and ammeters, both analog (needle) and digital ohmmeters are available. Digital ohmmeters are preferred for the same reasons that the other instruments are. Additionally, most digital ohmmeters have a diode scale which can be used to test diodes and transistors.

1-22. OHMMETER USE. Figures 1-12 through 1-14 illustrate some typical uses of the ohmmeter.

CAUTION

Typical heavy duty electrical system voltage (12 or 24 volts) could produce a current flow through the ohmmeter that could damage the meter. Never connect an ohmmeter to a circuit that is under voltage. Always disconnect the battery ground cable before using the ohmmeter.

1-23. As shown in Figures 1-12 and 1-13, the ohmmeter is also useful as a continuity meter. An infinite ohmmeter reading (See Figure 1-12) indicates an open circuit (no continuity). A very low (approaching zero) reading (See Figure 1-13) indicates continuity. Figure 1-14 illustrates some digital ohmmeter applications.

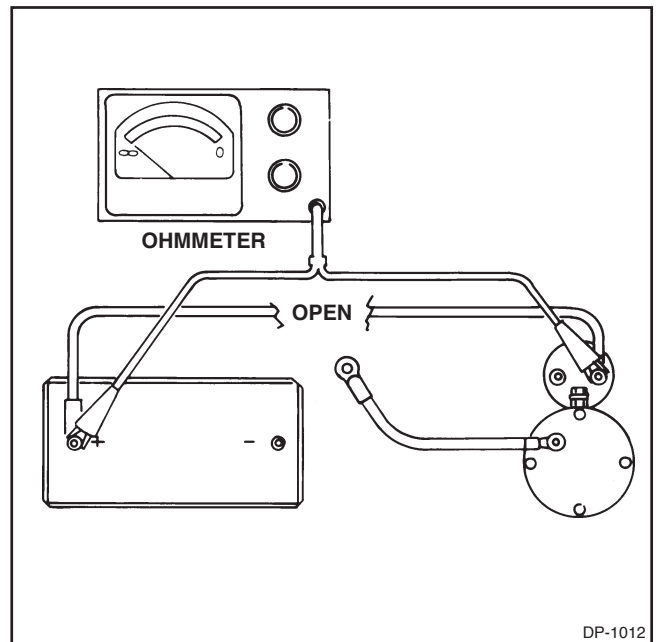

Figure 1-12. Analog Ohmmeter Showing Open Circuit

NOTE

Most digital meters have a diode scale (→▷▷▷) which must be used to check diodes or transistors rather than the ohm scale.

1-24. APPLYING AN ELECTRICAL LOAD WITH A CARBON PILE. (See Figure 1-15) The carbon pile is a variable resistor designed to carry high current. A carbon pile, along with a voltmeter and ammeter, is normally an integral part of a modern battery tester. In addition to load testing batteries, carbon piles are used to test starter and alternator circuits.

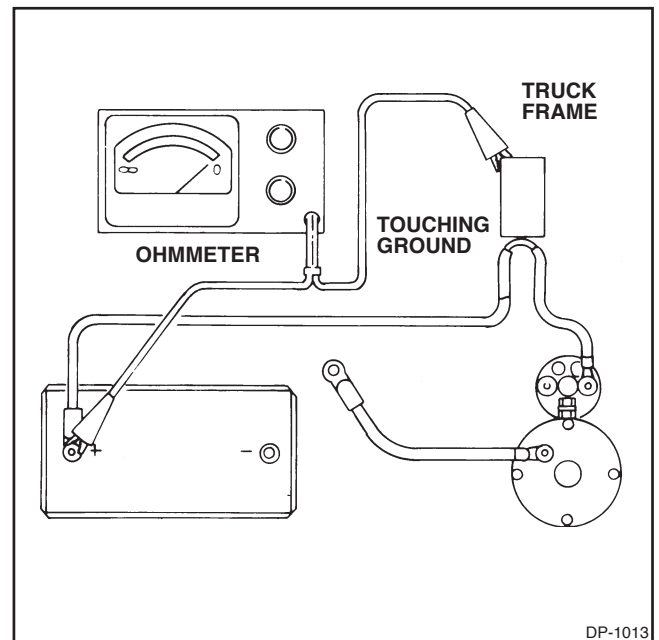

Figure 1-13. Analog Ohmmeter Showing Continuity

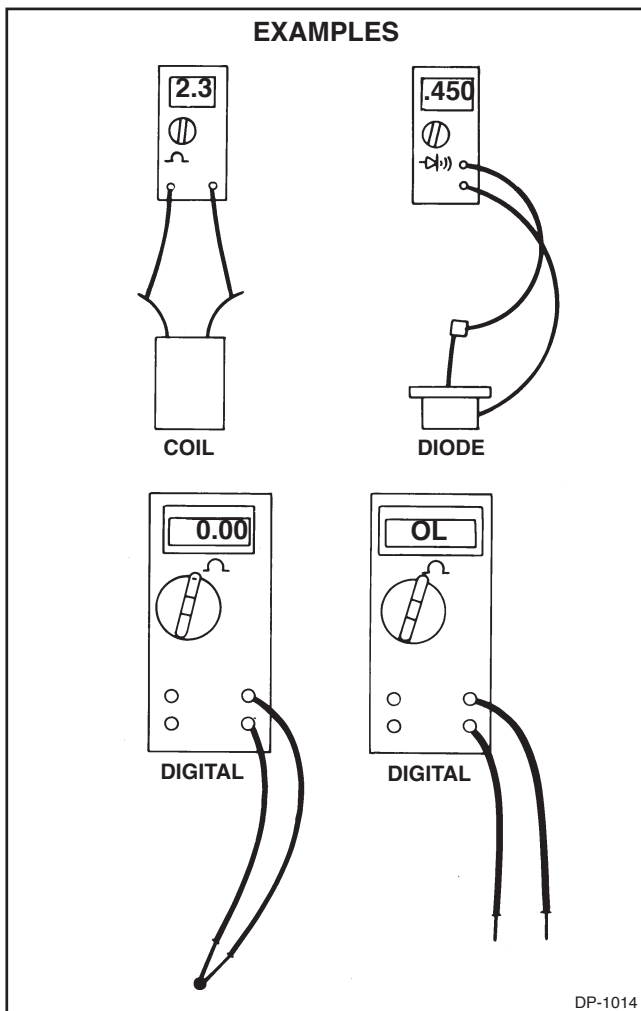

Figure 1-14. Digital Ohmmeter

CAUTION

On 24 volt systems, use only a carbon pile specifically designed for 24 volt use. A 12-volt carbon pile could be damaged if used in a 24 volt circuit.

1-25. THE BASIC HEAVY-DUTY ELECTRICAL SYSTEM. Today's basic heavy-duty electrical system (See Figure 1-1) consists of batteries (usually 3 or 4 connected), a starter, an alternator, a magnetic switch, an ignition switch, a pushbutton switch and the required wiring. The batteries provide the high current required by the starter. The magnetic switch controls the battery current to the starter solenoid. The ignition and pushbutton switches activate the magnetic switch which in turn energizes the starter. If all functions work properly, the engine will crank.

1-26. The mechanical energy of the running engine provides the power for the alternator. The alternator creates the electrical energy needed to recharge the batteries and power the vehicle's electrical accessories and loads.

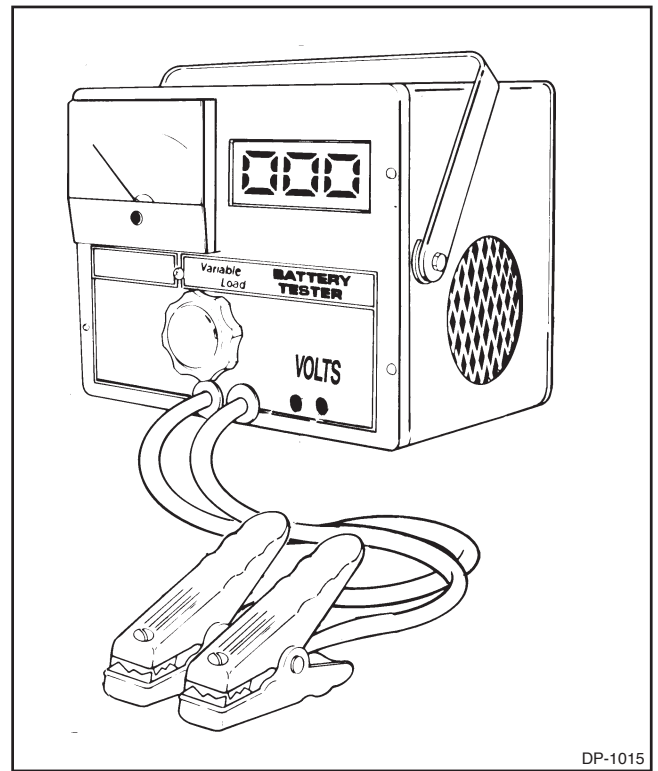

Figure 1-15. Carbon Pile

1-27. How well the electrical system components are matched will determine in a large part how effectively and efficiently the system will operate. Another important factor in system design is to ensure that system wiring is adequate to carry the current required by each circuit.

1-28. HEAVY DUTY SYSTEM BATTERIES. The battery, or more common batteries, in the heavy duty electrical system, are devices for storing energy. They convert chemical energy into the electrical energy needed to operate the starter. With the engine running the alternator supplies electrical energy to the batteries which they convert into chemical energy and store for later use. Three basic types of batteries may be encountered in heavy-duty electrical systems:

1. The Maintenance-Free Batteries. More common in today's systems, these batteries use lead-calcium grid construction without antimony. They never need water and there are no provisions for adding it, nor do they require any maintenance. Some heavy duty batteries are maintenance free and are available in several performance sizes with either post or stud terminal configurations.



DP-1016

Figure 1-16. Maintenance-Free Battery

2. The "Low Maintenance" or "Hybrid" Batteries. These batteries usually have Lead-Calcium grids in the negative plates and Lead-Antimony grids in the positive plates. They will use somewhat less water than a "Filler Cap" battery, but substantially more than a "Maintenance-Free" battery. They require regular servicing similar to that of "Filler Cap" batteries. Some means of replacing water is necessary and these batteries include a "plug strip" or individual covers over the filler holes which are removed to add water.

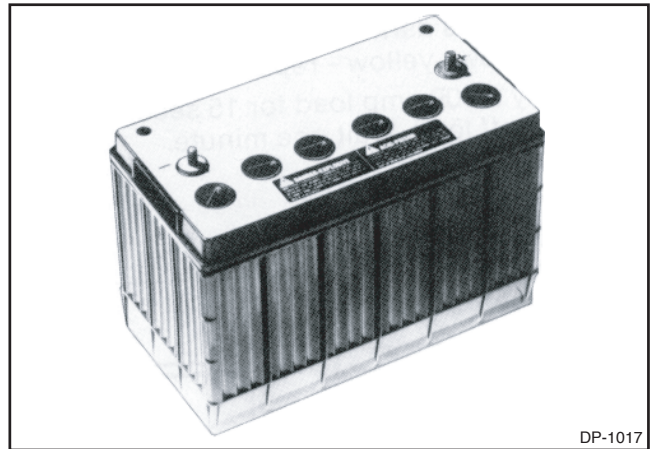

DP-1017

Figure 1-17. Low Maintenance (Hybrid) Battery

3. The Filler Cap Batteries. Not so common any more, these are lead-acid batteries with antimony in the grid alloy. The disadvantage of these batteries are that they require frequent servicing. Maintenance for these batteries includes adding water, cleaning posts and terminals with a wire brush and periodic cleaning of the battery surfaces, hold-downs and boxes with a baking soda and water solution.



DP-1018

1-18. Filler Cap Battery

Section II

DIAGNOSIS FLOW CHARTS

PRELIMINARY DIAGNOSIS FLOW CHART

2-1. OVERCHARGE SYMPTOMS

- High voltmeter readings
- Battery smells bad
- Battery spews acid or smells
- Bright or burned out lights

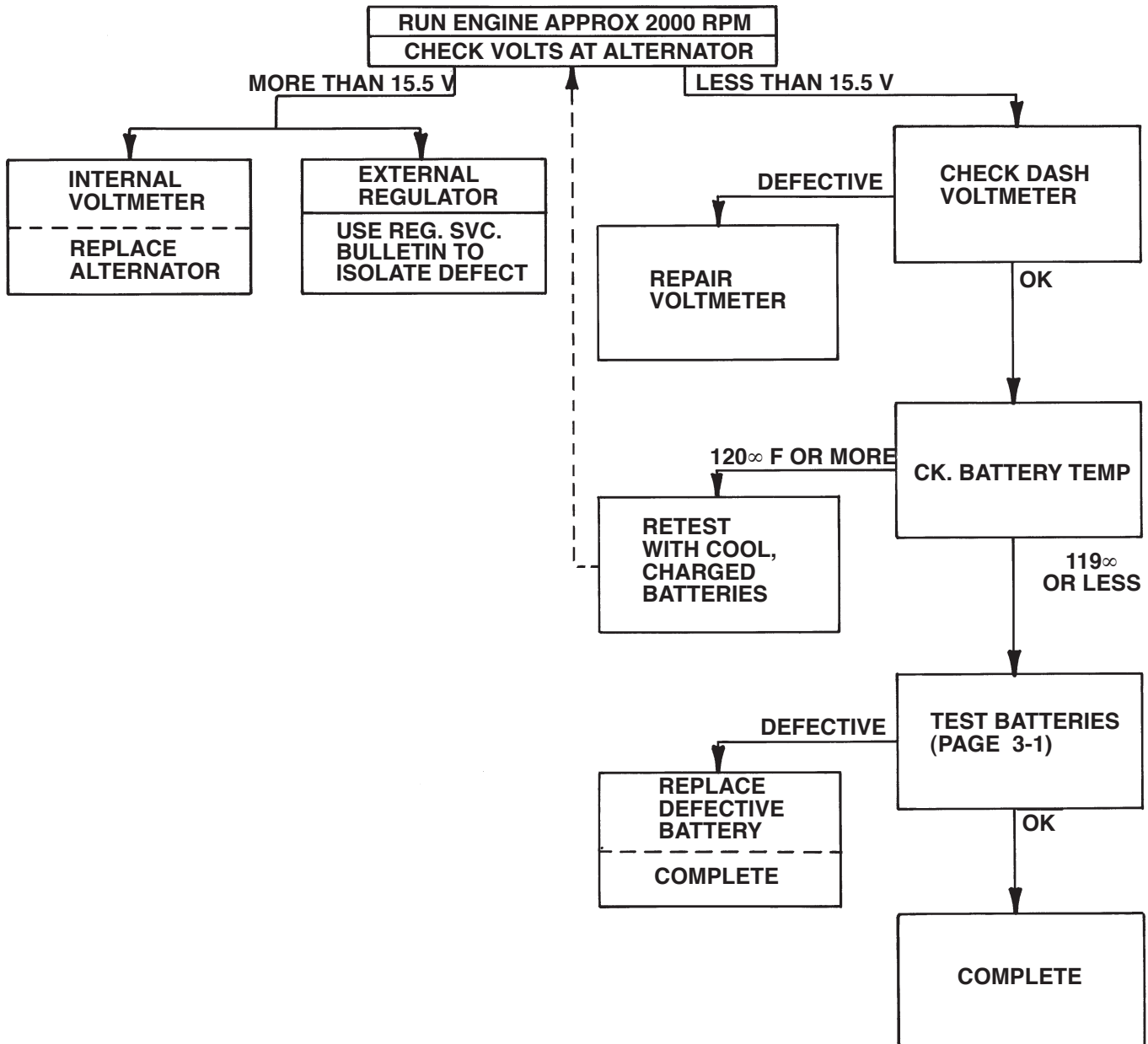

PRELIMINARY DIAGNOSIS FLOW CHART

2-2. UNDERCHARGE SYMPTOMS

- Slow or no cranking
- Low voltmeter reading
- Dim lights/slow turn signal flashers

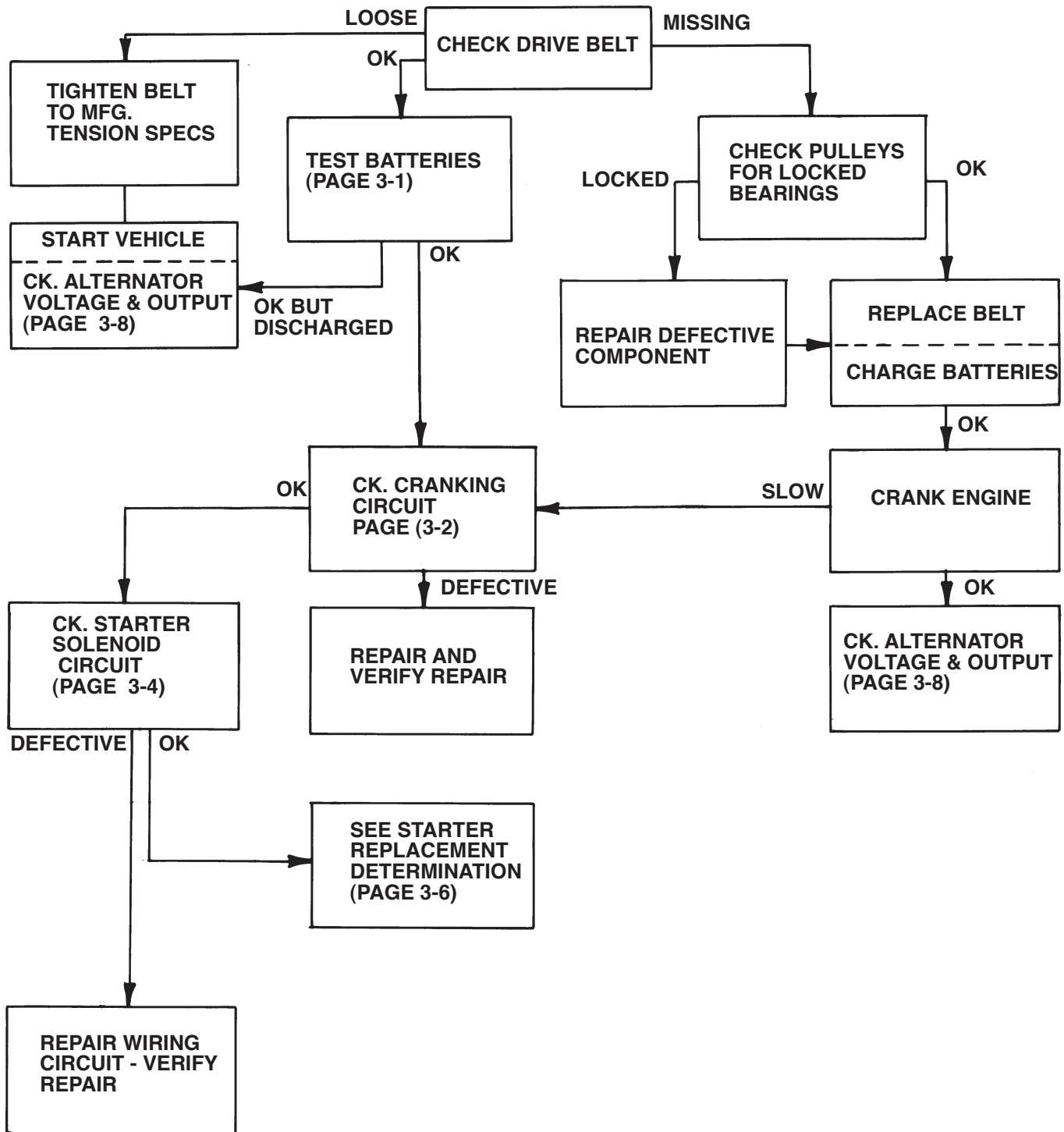

PRELIMINARY DIAGNOSIS FLOW CHART

2-3. MILLED PINION SYMPTOMS

- Starter spins/no crank
- "Click"/no crank (may be intermittent)

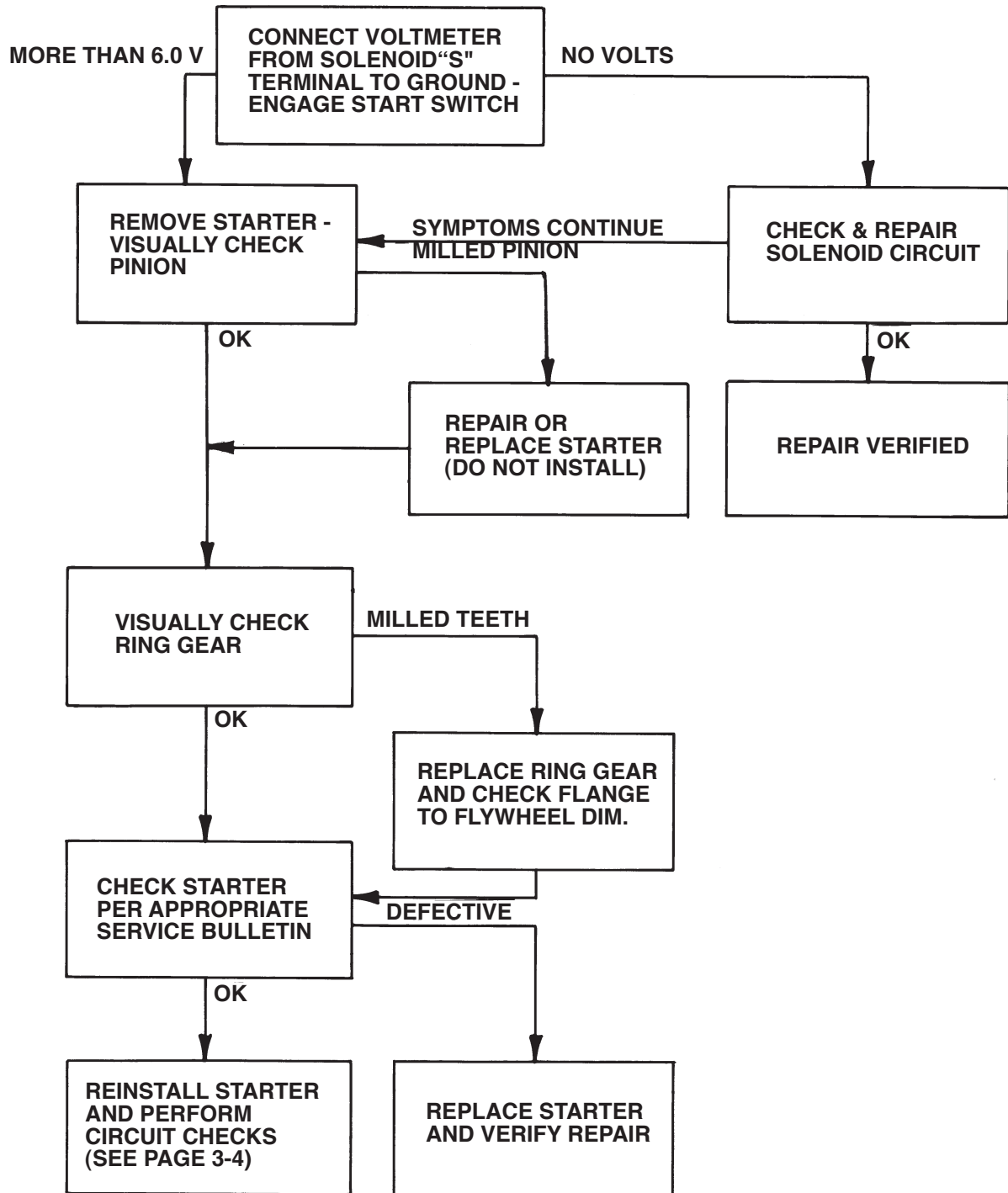

Section III

DIAGNOSTIC TESTING

3-1. TESTING FREEDOM BATTERIES

CAUTION

When handling batteries, wear face or eye protection and provide good ventilation. Have a water supply available and keep away from fire, flame or sparks.

3-2. TEST PROCEDURE.

 Disconnect

NOTICE

If battery has threaded terminals, use terminal adapters, AC-Delco No. ST-1201, on each terminal when testing or charging.

 Inspect

1. Each battery visually for damage.
2. Battery hydrometer eye.
 - If battery has no hydrometer eye, proceed to step 3.
 - Eye shows green, proceed to step 3.
 - Eye shows dark, recharge battery then proceed to step 3.
 - Eye shows yellow, replace battery.
3. Apply 300 amp load to battery for 15 seconds and turn off load. Wait one minute.
4. If battery has no hydrometer eye, measure terminal voltage:

 Test

- a. If 12.4 volts or more, continue test.
- b. If less than 12.4 volts, recharge battery and repeat steps 3 and 4.

 Test

5. All batteries passing previous inspection or test, as follows:
 - a. Apply test load of 1\2 CCA rating @ 0°F in amps.
 - b. After 15 seconds with load on, measure and record battery terminal voltage.
 - c. Turn load off.
 - d. Estimate battery temperature and check recorded voltage against following table.

Temp. °F	70	50	30	15	0
Min. Volts	9.6	9.4	9.1	8.8	8.5

- e. If recorded voltage does not meet or exceed that in table, replace battery. Otherwise battery is OK.

3-3. TEST COMPLETION.

 Clean

1. Cable ends and battery terminals with wire brush.

 Tighten

1. Battery hold-downs to specifications.

NOTICE

Leave battery cables disconnected and proceed with wiring tests.

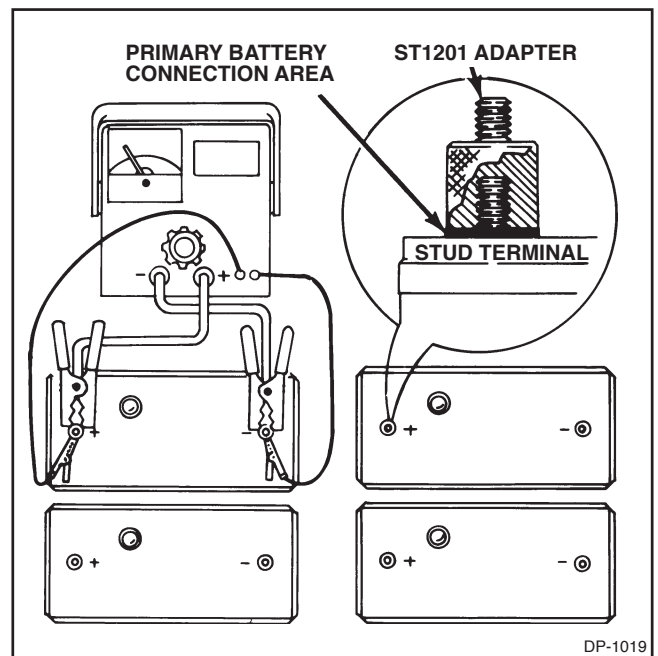

Figure 3-1. Testing Batteries

3-4. TESTING CONVENTIONAL BATTERIES

CAUTION

When handling batteries, wear face or eye protection and provide good ventilation. Have a water supply available and keep away from fire, flame or sparks.

3-5. TEST PROCEDURE

 **Disconnect**

NOTICE

If battery has threaded terminals, use terminal adapters, AC-Delco No. ST-1201, on each terminal when testing or charging.

 **Inspect**

1. Each battery visually for damage.
2. Electrolyte level.
 - If fluid is above top of plates in all cells, proceed to step 3.
 - If fluid is not above top of all plates, add water as required and charge battery for 15 minutes at 15-25 amps to mix electrolyte. Then proceed to step 3.
3. Electrolyte specific gravity with hydrometer at 80°F. Readings for all cells shall be not less than 1.230. Difference between high and low reading shall not exceed 0.050.
 - If battery meets above requirements, proceed to next test.
 - If readings show difference more than 0.050, replace battery.
 - If readings show less than 0.050 difference but one or more cells read less than 1.230, recharge battery.

 **Remove**

1. All battery caps

 **Test**

1. Apply 300 amp load to battery for 15 seconds and turn off load.
2. If blue haze is seen in any cell, replace battery. Otherwise proceed with next test.

 **Test**

1. All batteries passing previous inspections or tests, as follows:
 - a. Measure and record electrolyte temperature and replace vent caps.
 - b. Apply test load of 1\2 CCA rating @ 0°F in amps.
 - c. After 15 seconds with load on, measure and record battery terminal voltage.
 - d. Turn load off.
 - e. Check recorded voltage against following table for electrolyte temperature

Temp. °F	70	60	50	40	30	20	10	0
Min. Volts	9.6	9.5	9.4	9.3	9.1	8.9	8.7	8.5

- f. If recorded voltage does not meet or exceed that in table, replace battery. Otherwise battery is OK.

3-6. TEST COMPLETION.

 **Clean**

1. Cable ends and battery terminals with wire brush.

 **Tighten**

1. Battery hold-downs to specifications.

NOTICE

Leave battery cables disconnected and proceed with wiring tests.

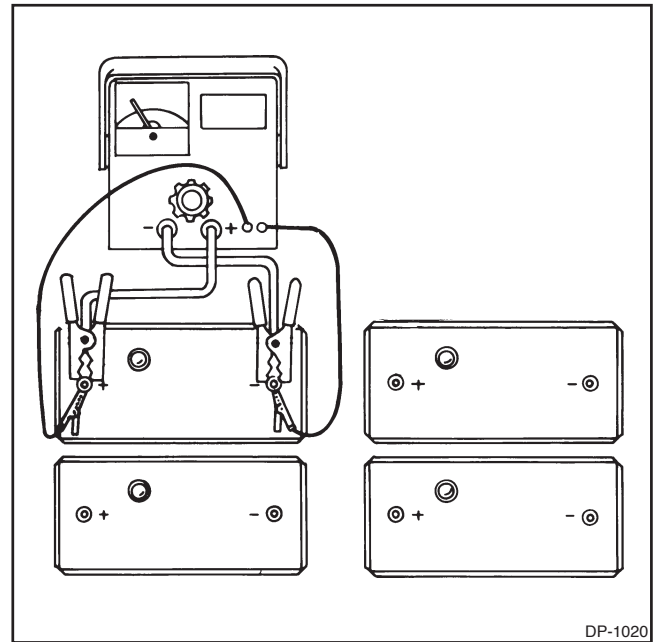

Figure 3-2. Testing Batteries

3-7. BATTERY CABLE TEST WITH SINGLE BATTERY LOCATION (SEE FIGURE 3-3)

CAUTION

If the vehicle has a combination 12/24 volt system using a series-parallel switch or a T/R alternator, do not use this procedure. Contact Delco Remy International Field Service at 1-800-DRA-0222 for information on such systems.

Slow or sluggish cranking may be caused by high resistance in the battery cables or connections, especially in cold weather. After all batteries test good and the terminals are clean, check the battery cables. This involves placing an adjustable carbon pile load on the batteries at the starter and then measuring the voltage drop in each cable. The voltage drop in the positive cable plus the voltage drop in the negative cable equals the total drop which is the difference between the battery voltage and the starter voltage.

3-8. TEST PROCEDURE.

NOTICE

For 24 volt system use 24 volt carbon pile. As an alternate, connect only one 12-volt battery to the system (disconnect all other batteries). Test at 12 volts but use the amperage specified for a 24 volt system. Immediately upon completion of tests, reconnect batteries in the approved manner for 24 volt system.

→← Connect

CAUTION

Starter solenoid "BAT" terminal is at battery voltage when batteries are connected.

1. Positive carbon pile lead to starter solenoid "BAT" terminal.
2. Negative carbon pile lead to starter ground terminal.
3. Battery cables (see NOTICE above) if not already connected.

NOTICE

At starter, make voltmeter connection to terminal—not to carbon pile clamp.

4. Low scale digital voltmeter from starter solenoid "BAT" terminal to battery positive.

T Test

1. Turn on carbon pile and adjust load to 500 amps (250 amps for 24 volt system).
2. Read and record positive cable voltage drop (V4) then turn off carbon pile.

→← Connect

NOTICE

At starter, make voltmeter connection to terminal—not to carbon pile clamp.

1. Low scale digital voltmeter from starter ground terminal to battery negative.

T Test

1. Turn on carbon pile and adjust load to 500 amps (250 amps for 24 volt system).
2. Read and record negative cable voltage drop (V5) then turn off carbon pile.
3. Add positive cable loss (V4) and negative cable loss (V5) to get total cable loss (V3). This loss (V3) shall not exceed:

- 12 volt system with 37 MT, 40 MT, 41 MT or 42 MT starter - 0.500 volt maximum voltage loss
- 12 volt system with 50 MT starter - 0.400 volt maximum loss
- 24 volt system with 37 MT, 40 MT, 41 MT, 42 MT or 50 MT starter - 1.000 volt

4. Replace cables or repair circuits with excessive voltage drop.

3-9. TEST COMPLETION. If temporary 12 volt test connections were made for 24 volt system, reconnect batteries to vehicle specifications for 24 volt operation before starting vehicle. However, if the tests following are to be performed, keep the temporary 12 volt hook-up.

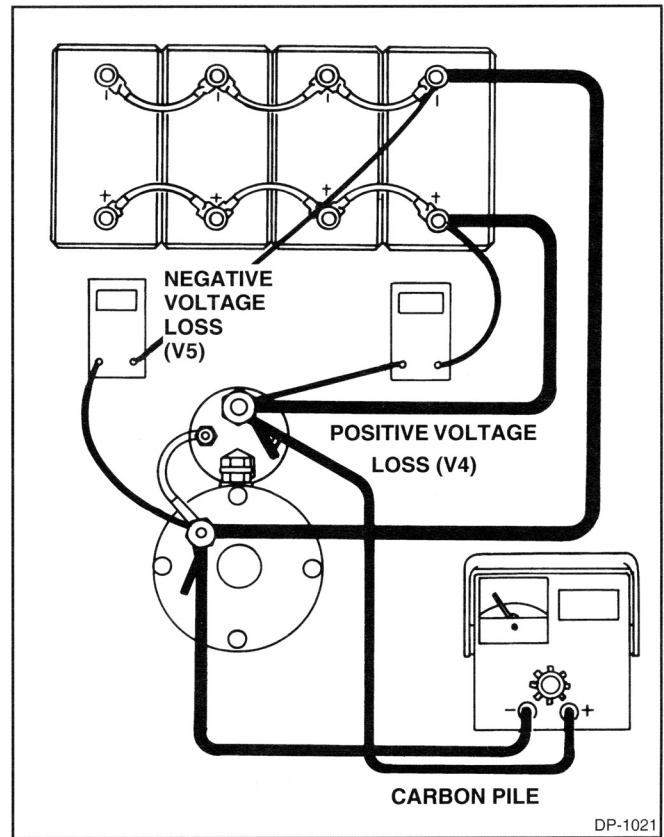

Figure 3-3. Battery Cable Test
- Typical 12 Volt System

3-10. BATTERY CABLE TEST WITH DUAL-BATTERY LOCATIONS (SEE FIGURE 3-4)

This test applies if the vehicle has more than one battery location and the batteries are connected to the starter by separate cables. Essentially, this is the same as the previous test with a single battery location (paragraphs 3-7 through 3-9) except as follows:

3-11. TEST PROCEDURE (See Figure 3-4).

NOTICE

If the system usually operates on 24 volts, connect one battery at each location to the starting motor, making a temporary 12 volt system.

1. Disconnect batteries from first set.
2. Test second set cables as described in paragraph 3-8 except apply 250 amp load at starter (125 amp for 24 volt system).
3. Use same voltage drop or loss limits as specified in paragraph 3-8.

4. Reconnect first set of batteries and disconnect second set.

5. Repeat steps 2 and 3 for first set of cables.

6. Replace cables or repair circuits with excessive voltage drop.

3-12. TEST COMPLETION. If temporary 12 volt test connections were made for 24 volt system, reconnect batteries to vehicle specifications for 24 volt operation before starting vehicle. However, if the tests following are to be performed, keep the temporary 12 volt hook-up.

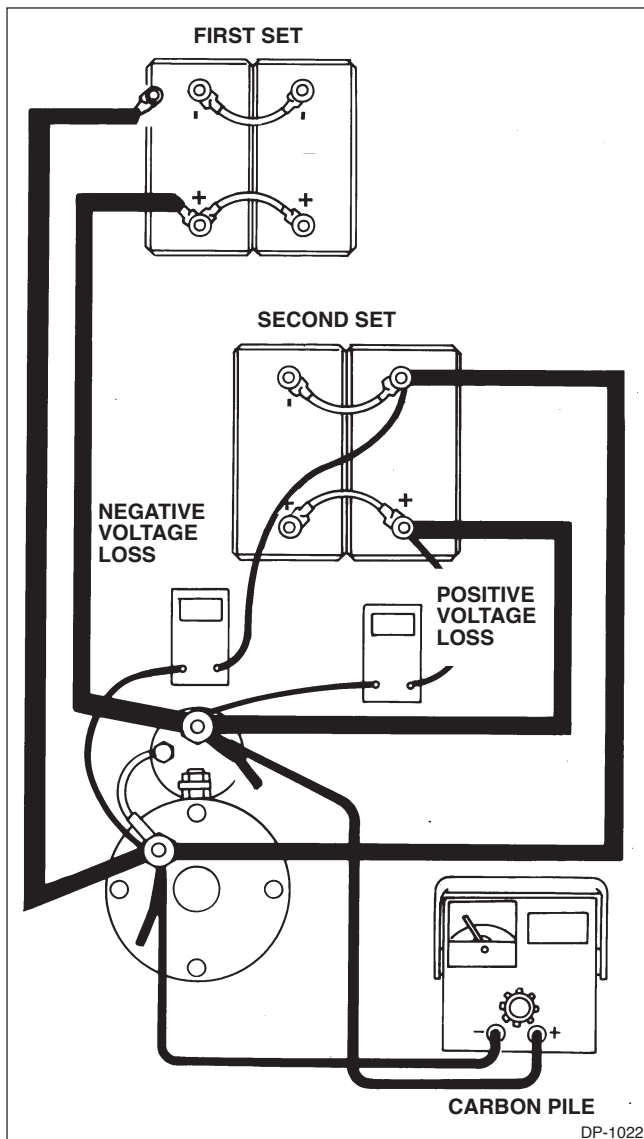

Figure 3-4. Battery Cable Test - Typical Dual Box 12 Volt System

3-13. STARTER SOLENOID CIRCUIT TEST

The starter shifting in and out, or not pulling in, is often caused by high resistance in the starter solenoid circuit. When the solenoid circuit has excessive voltage loss, the starter pinion may not engage the flywheel. If it does engage, it may drop out too soon when battery voltage lowers. The solenoid circuit usually consists of a magnetic switch with leads to and from the starter solenoid. Some vehicles use only a pushbutton switch to control the starter solenoid and this same test applies.

NOTICE

For starters with an integral magnetic switch, use the test procedures specific to those starters.

NOTICE

When testing 24 volt systems, use the same temporary 12 volt connection as for Battery Cable Test, paragraph 3-7.

3-14. SOLENOID CIRCUIT VOLTAGE LOSS TEST (See Figure 3-5).

 Disconnect

1. Lead to "S" terminal on starter solenoid.

 Connect

1. Carbon pile to switch wire lead and to starter ground terminal (a small clamp or jumper wire may be helpful).

2. Positive lead of digital voltmeter set on low scale to solenoid "BAT" terminal.

3. Negative lead of voltmeter to switch wire lead to which carbon pile is connected. Meter will show battery voltage.

NOTICE

In the following step, if the magnetic switch does not close on a 12 volt vehicle, perform Magnetic Switch Circuit Test, paragraph 3-18, then return to this point in the Starter Solenoid Circuit Test.

NOTICE

In the following step, on a 24 volt vehicle, if the temporary 12 volt system will not close the magnetic switch, bypass it with a heavy jumper connected between the two large studs on the magnetic switch. electrically this does the same thing as pushing the button and closing the switch. With no button to release, the jumper must be disconnected after each voltage reading.

 Test

1. Have assistant push starter button with key on. Listen for sound of magnetic switch closing. Voltmeter reading should be zero.

2. Turn on and adjust carbon pile to 100 amp load (60 amp if 24 volt system).

3. Read and record voltage (V6) on voltmeter.

4. Voltage loss shall not exceed:

12 volt system - 1.0 volt

24 volt system - 2.0 volt

5. If circuit voltage loss is less than maximum, solenoid circuit is OK, Turn off and disconnect carbon pile and proceed to Magnetic Switch Circuit Test, paragraph 3-18. If voltage loss exceeds maximum, loss is excessive. This may be caused by loose terminals, corrosion, too small wire, switch located too far from starter, or worn out magnetic switch. Perform Wiring Test, paragraph 3-15 and Magnetic Switch Contactor Test, paragraph 3-16 to isolate the problem.

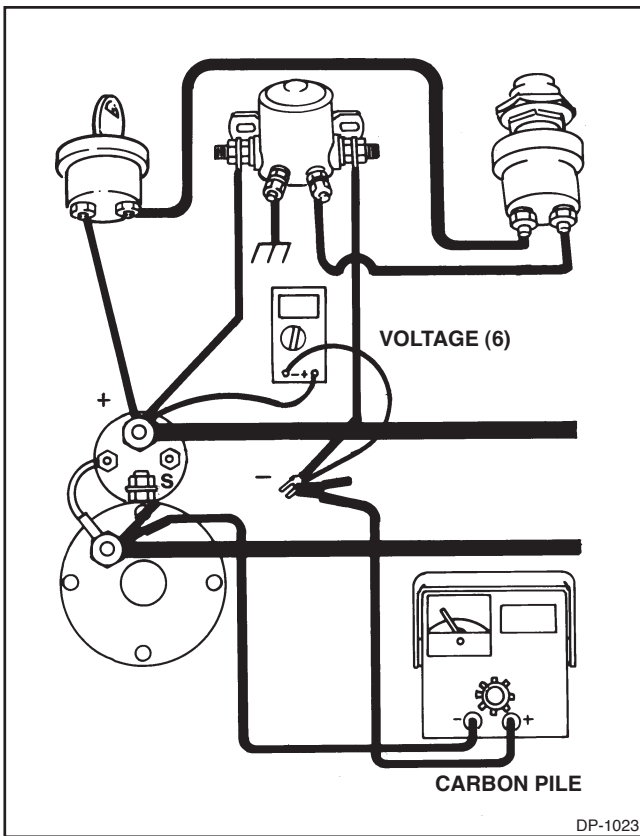

Figure 3-5. Starter Solenoid Circuit Test

3-15. WIRING TEST (See Figure 3-6). With carbon pile connected as for previous Starter Solenoid Circuit Test, proceed as follows:

→→ Connect

1. Plus lead of digital voltmeter set on low scale to solenoid "BAT" terminal.
2. Minus lead of voltmeter to a large terminal on magnetic switch. If voltage shows, reconnect lead to other large terminal on magnetic switch.

NOTICE

In the following step, on a 24 volt vehicle, if the temporary 12 volt system will not close the magnetic switch, bypass it with a heavy jumper connected between the two large studs on the magnetic switch. electrically this does the same thing as pushing the button and closing the switch. With no button to release, the jumper must be disconnected after each voltage reading.

T Test

1. Push starter button with key on.
2. Turn on and adjust carbon pile to 100 amp load (60 amp if 24 volt system).
3. Read and record voltage (V9) on voltmeter.

→→ Connect

1. Positive lead of digital voltmeter set on low scale to switch wire lead to which carbon pile is connected.
2. Negative lead of voltmeter to other large terminal on magnetic switch.

T Test

1. Push starter button with key on.
2. Turn on and adjust carbon pile to 100 amp load (60 amp if 24 volt system).
3. Read and record voltage (V10) on voltmeter.
4. Add voltage loss (V10) to voltage loss (V9) previously recorded to get total wire voltage loss.
5. Total wire voltage loss shall not exceed:
12 volt system - 0.8 volt
24 volt system - 1.8 volt
6. Replace and repair wiring and connections if voltage loss is excessive.

NOTICE

Perform the following test only if the magnetic switch closed in preceding tests.

3-16. MAGNETIC SWITCH CONTACTOR TEST (See Figure 3-6). With carbon pile connected as for previous Starter Solenoid Circuit Test, proceed as follows:

→→ Connect

1. Digital voltmeter set on low scale across large terminals of magnetic switch. Battery voltage will show immediately.

T Test

1. Push starter button with key on. Voltage will read zero.
2. Turn on and adjust carbon pile to 100 amp load (60 amp if 24 volt system).
3. Read and record voltage (V11) across magnetic switch on voltmeter then release starter button.
4. Magnetic switch contactor voltage loss (V11) shall not exceed 0.2 volts for 12 or 24 volt system.
5. Replace magnetic switch if contactor voltage loss is excessive.

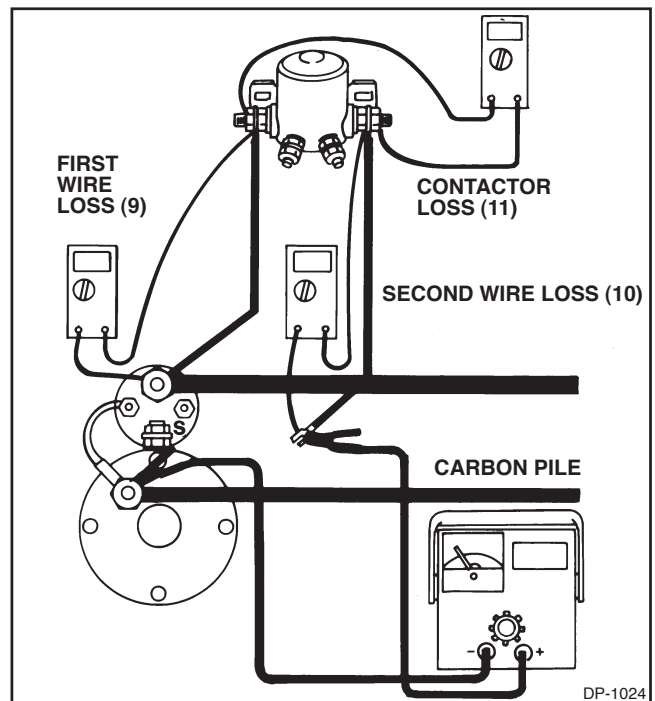

Figure 3-6. Solenoid Circuit Wiring and Contactor Test

3-17. TEST COMPLETION. Turn carbon pile off. Remove carbon pile and voltmeter from circuit. Leave solenoid "S" wire disconnected and temporarily taped for insulation at the terminal

3-18. MAGNETIC SWITCH CIRCUIT TEST

For motors which include the Magnetic Switch as part of the motor (42 MT IMS), refer to Delco Field Service Bulletin DR7789.

This test must be performed using full voltage of the system. If a 24 volt system was temporarily connected into a 12 volt system for previous test, proceed to the Alternator Wiring Test, paragraph 3-26. Then, return to this test after the batteries have been reconnected back to a 24 volt system. Note that the lead to the "S" terminal on the starter solenoid remains disconnected from previous tests (See Figure 3-7).

3-19. TEST PROCEDURE.

NOTICE

Magnetic switch that does not close or drops out too soon can be caused by high resistance or open circuit in the control circuit.

NOTICE

Leave the "S" lead disconnected to prevent engine from cranking during these tests.

 **Connect**

1. Digital voltmeter set on battery voltage scale to two small terminals on magnetic switch. If magnetic switch has only one small terminal, use switch bracket for other connection.

 **Test**

1. With key on, push start button. Listen for click that signifies magnetic switch closing. Note and record voltmeter reading V(13).

2. If magnetic switch closed (click detected or voltage at both large switch terminals) and voltage V(13) is within 1.0 volt (2.0 volts for 24 volt system) of battery voltage V(12), this circuit is OK.

3. If magnetic switch does not close and voltage V(13) is within 1.0 volt (2.0 volt for 24 volt system) of battery voltage V(12), replace magnetic switch and retest.

4. If voltage V(13) is more than 1.0 volt (2.0 volt for 24 volt system) below battery voltage, move the voltmeter lead on the magnetic switch ground to frame or motor ground terminal. With key on, push start button and read voltage V(14). If voltage V(14) is within 1.0 volt (2.0 volts for 24 volt system) of battery voltage, repair magnetic switch ground lead or connections. If not, replace voltmeter ground lead at magnetic switch ground terminal

5. Repeat step 4 moving voltmeter plus lead to the following locations and measuring the specified voltages with the key on and the pushbutton depressed.

If any voltage is not within 1.0 volt (2.0 volts for 24 volt system) of battery voltage, repair or replace the wire or component specified and retest:

- V(15)-wire between pushbutton and magnetic switch
- V(16)-pushbutton
- V(17)-wire between pushbutton and key switch
- V(18)-key switch
- V(19)-wire between key switch and solenoid "BAT" terminal

3-20. TEST COMPLETION. Remove voltmeter from vehicle. If all tests have been completed satisfactorily, reconnect lead to "S" terminal on starter solenoid so that engine can be started.

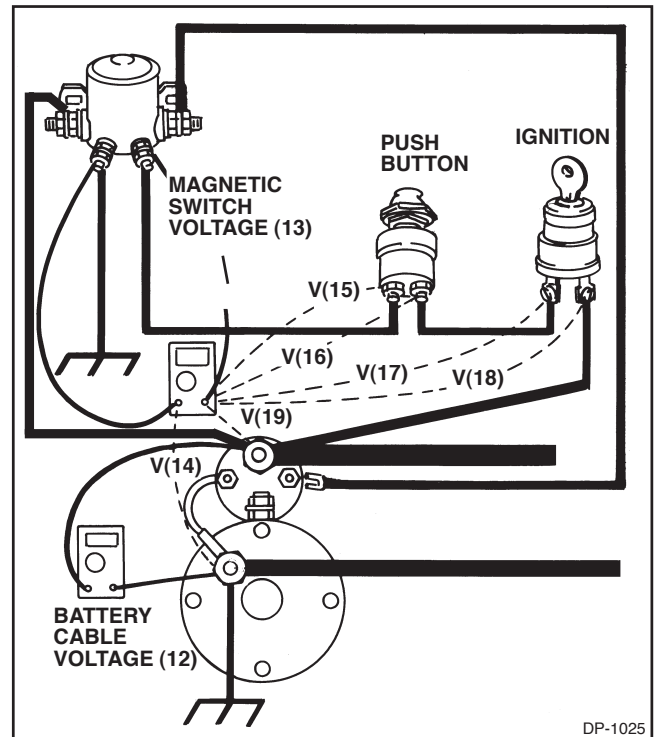

Figure 3-7. Magnetic Switch Circuit Test

3-21. STARTER REPLACEMENT DETERMINATION

Up to this point, the batteries and starter wiring have been checked. Following are additional checks which should be made before considering starter replacement, and finally the criteria for starter replacement if necessary.

3-22. COLD WEATHER CRANKING. Starter circuits with a magnetic switch can also fail to hold in during cold weather starting and low voltage even though the switches and circuits tested OK at higher temperatures. This condition will sound as though the starter is failing to stay engaged with the engine. It is caused by the cold weather low voltage of the system releasing the electrical connection of the magnetic switch. To test for this condition, proceed as follows:

Test

CAUTION

Large terminal studs on magnetic switch are at battery voltage. Engine should crank when jumper is connected.

1. With key switch on, press start button and have assistant clamp heavy battery jumper cable between two large studs on magnetic switch. Engine should crank.

2. Immediately remove jumper to stop engine cranking.

3. If engine starts with jumper in place, replace magnetic switch.

4. If vehicle now starts properly, make sure starter mounting bolts are tight and proceed to Alternator Wiring Test.

3-23. AVAILABLE CRANKING VOLTAGE. If batteries, switches and wiring have been checked and starter still cranks slowly, check for available voltage at the starter while cranking. Proceed as follows:

Test

1. Have assistant press pushbutton with key switch on while measuring voltage across solenoid "BAT" terminal and starter ground terminal.

2. If voltage is 9.0 volts (18 volts for 24 volt system) or less while cranking, check battery interconnecting cables as specified in next step.

3. Measure voltage across each battery while cranking. Touch voltmeter leads to terminals of every battery. If difference between any two battery readings in same box is more than 0.5 volt, or if any cable or connection feels warm to the touch, check or replace interconnecting cable(s) as required.

3-24. RING GEAR AND PINION CHECK. One final check before replacing the starter is to inspect the pinion and ring gear.

Inspect

1. Pinion and ring gear visually while assistant bars engine over. Be sure to check entire ring gear.

2. If pinion is damaged, replace starter. If ring gear is damaged, replace ring gear, noting that if ring gear is damaged there is a likelihood that pinion may also be damaged.

3-25. STARTER REPLACEMENT. After making all tests specified, if the vehicle does not crank properly, the problem must be with the starter or the engine. Replace the starter and recheck to see if engine cranks properly. If not, then look for a mechanical problem with the engine.

3-26. ALTERNATOR WIRING TEST

This procedure is the first step in checking out the charging system. The output of the alternator the batteries and the accessory loads with a minimum of voltage loss. Any loss slows the rate of charge to the batteries and could cause the batteries to be partially discharged. Discharged batteries can result in starter damage. Low output voltage can cause improper performance of other vehicle electrical components.

3-27. TEST PROCEDURE (See Figure 3-8). Instead of using the alternator output, this test uses the same current but draws it from the batteries. Using a carbon pile load, current flows in reverse through the circuit with the engine off. Proceed as follows:

NOTICE

24 volt systems must be connected into a temporary 12 volt configuration as described for Battery Cable Test, paragraph 3-8.

NOTICE

Before proceeding with this test, make sure that the batteries have been tested and that the terminal have been cleaned and tightened.

CAUTION

Alternator output terminal is at battery voltage. Engine must be off for this test.

Connect

1. Carbon pile to alternator output terminal and to ground.

NOTICE

Jumper wires may be used to extend voltmeter leads if necessary.

2. Digital voltmeter set on low scale from alternator output terminal to positive battery terminal.

Test

1. Turn on and adjust carbon pile to alternator rated amperage output.

2. Read voltmeter and record voltage (V24) which is positive circuit voltage loss. Immediately turn off carbon pile.

Connect

1. Digital voltmeter set on low scale from alternator ground to negative battery terminal.

T Test

1. Turn on and adjust carbon pile to alternator rated amperage output.

2. Read voltmeter and record voltage (V25) which is negative circuit voltage loss. Immediately turn off carbon pile.

3. Add positive circuit loss (V24) and negative circuit loss (V25) to get total system loss (V23). This loss (V23) shall not exceed:

- 12 volt system - 0.500 volt maximum voltage loss
- 24 volt system - 1.000 volt maximum voltage loss

4. Replace cables or repair circuits with excessive voltage loss.

3-28. TEST COMPLETION. Remove carbon pile and voltmeter. For 12 volt systems proceed with Alternator Replacement Determination. For 24 volt systems, proceed as follows:

1. Reconnect temporary 12 volt system back to 24 volt system.

2. If Magnetic Switch Circuit Test was delayed, conduct at this time.

3. After completing Magnetic Switch Circuit Test, be sure to reconnect lead to "S" starter solenoid terminal. Then proceed with Alternator Replacement Determination.

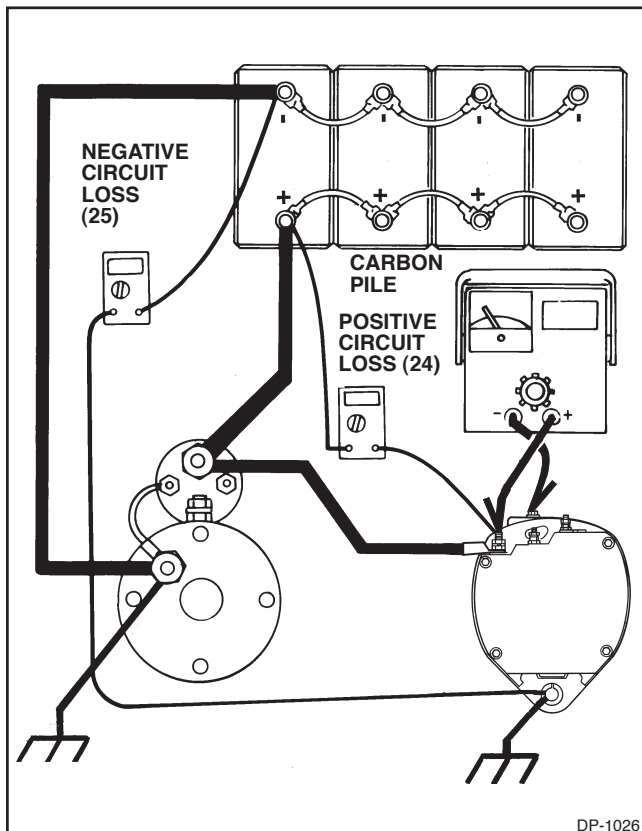

Figure 3-8. Alternator Wiring Test - Typical 12Volt System

3-29. ALTERNATOR REPLACEMENT DETERMINATION

If the alternator wiring circuits are OK, conduct the following tests to determine if the alternator must be replaced.

NOTICE

Make sure that alternator mounting hardware is secure and that belts are OK before testing alternator.

NOTICE

Batteries shall have been satisfactorily load tested and must be near full charge with more than 12.4 Volts no load voltage.

3-30. ALTERNATOR VOLTAGE OUTPUT TEST.

Conduct this test at shop temperature (See Figure 3-9).

Connect

1. Digital voltmeter from positive alternator terminal to alternator ground.

T Test

1. Start engine and make sure all vehicle electrical loads are turned off. Fast idle engine until voltage stabilizes (does not increase) for two minutes.

2. Check that alternator output voltage does not exceed 15.5 volts (31 volts for 24 volt system). Remove voltmeter.

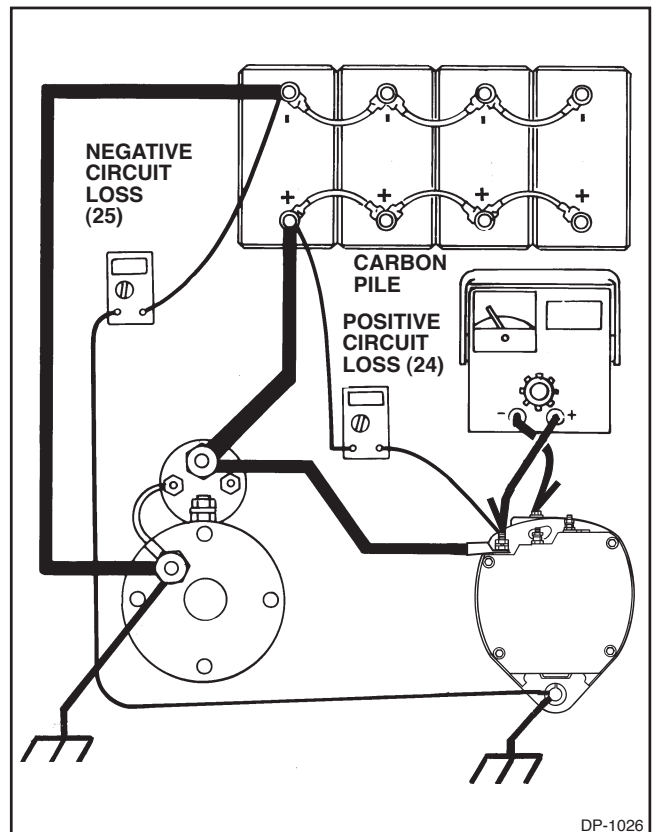

Figure 3-8. Alternator Wiring Test - Typical 12Volt System

3-31. ALTERNATOR AMPERAGE OUTPUT TEST. Conduct this test at shop temperature (See Figure 3-10).

Connect

1. Carbon pile across the vehicle batteries hooked in parallel.
2. Induction ammeter, clamped around alternator output wire.

NOTICE

If more than one wire is connected to the alternator output terminal, clamp around ALL these wires.

Test

NOTICE

In following test, alternator should be turning at approximate rated speed. Most heavy-duty alternators are rated at 5000 rpm. Check manufacturer's specifications for specific alternator being tested.

1. If off, start engine and make sure all vehicle electrical loads are turned off. Speed up engine. Turn on and adjust carbon pile until ammeter reads its highest value. Record this reading.
2. Turn off carbon pile and engine.
3. If reading is zero (no output), magnetize the rotor with the alternator hooked up normally. Momentarily connect a jumper lead from the battery positive (+) to the alternator relay (R) or indicator (I) terminal. This procedure applies to both negative and positive ground systems, and will restore the normal residual magnetism.
4. Repeat steps 1 and 2. If output is still zero, replace the alternator.

3-32. ALTERNATOR REPLACEMENT. Replace alternator if either of the following conditions exist:

1. Alternator output voltage exceeds 15.5 volts (paragraph 3-30). If alternator has separate regulator, use the appropriate regulator service bulletin to isolate the defect.

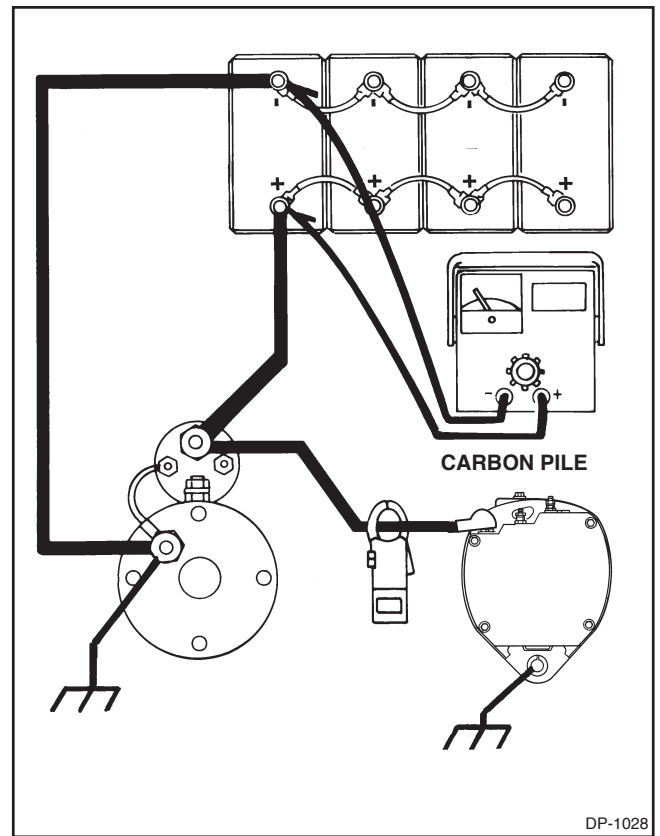

Figure 3-10. Amperage Output Test

2. Alternator output current is not within 10% of alternator rated output (stamped on alternator case). Examples: 30-SI - 105 amps, 26-SI - 85 amps, 21-SI - 100 amps.

3-33. COMPLETION OF ALL TESTS

Make sure that all test instruments have been removed from the vehicle and that the vehicle wiring, if altered, has been returned to the operational state.

Section IV

SUMMARY

At Delco Remy International, we believe that these diagnostic procedures, if followed correctly, will enable you to diagnose trouble and maintain your heavy duty electrical system so that it will perform well and provide good service. However, we also realize that these procedures may not handle all of the infinite number of variables that may be encountered. In such cases, your experience, knowledge and good judgement will prove to be invaluable. If you need help, our experience is available with a phone call.

Dial 1-800-DRA-0222.

At first glance the procedures specified in this manual may seem to be complex and lengthy. Actually, with

practice and experience they become quite simple. As maintenance personnel gain confidence and competency with these procedures they may easily become part of routine preventative maintenance.

Remember two things as you improve your diagnostic efforts with this manual:

1. Don't jump to early conclusions.
2. Perform the diagnostic procedures in the exact order that they are give in this manual.

With this manual as a reference and with practice and experience, your diagnostic skills will become both effective and efficient.



Section V

APPENDIX

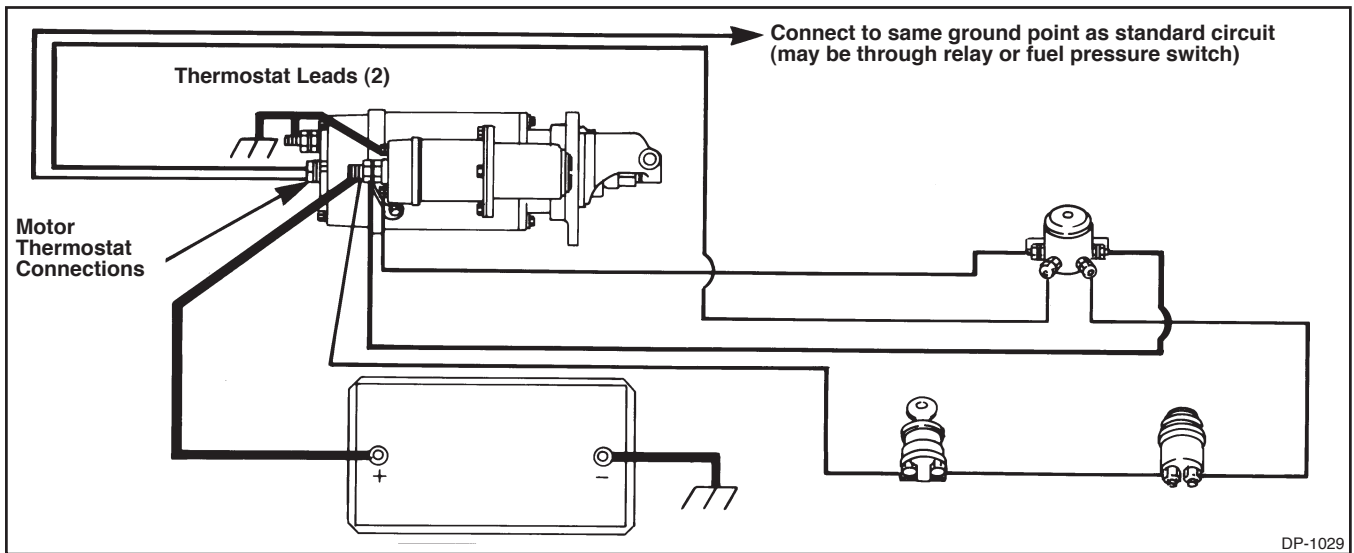

42-MT With Overcrank Protection

5-1 Overcrank Protection (OCP) Circuit Check

To check the thermostat in the OCP circuit for continuity, detach wiring harness connector and connect an ohmmeter to the two thermostat terminals on the starter. The ohmmeter should read zero. If not, thermostat is open circuit and the starter should be replaced prior to proceeding with other tests in this booklet.

DO NOT check thermostat when hot, since it is supposed to be open-circuit above certain temperatures.

5-2. Multi-Battery Charging with Series and Parallel Chargers

The charging procedures that will be discussed are to provide good and charged batteries for future service. "Boost" charging or "fast" charging is not discussed. This bulletin provides basic guide lines for charging groups of batteries and supplements information contained in the Delco Service Bulletins, 1B-115 and 1B-116.

The two basic types of battery chargers in use today for charging a group of batteries are:

- The Current-Limiting Type (often called Constant Current or Series Chargers)
- The Voltage-Limiting Type (often called Constant-Voltage or Parallel Chargers)

With the Series Chargers, the batteries are connected so that each battery receives the same amount of charging current. (See Fig. 1 for typical hook-up.)

With Parallel Chargers, the batteries are connected so that the charging current is divided and each battery receives only the charging current it can accept at the charger's voltage. (See Fig. 2 for typical hook-up.) Because of these differences, the charging procedures also differ.

No matter which type of charger is used, differences exist between batteries: age, capacity or size, state of charge, and type. These differences mean that time and attention must be given to batteries during the group-charging process.

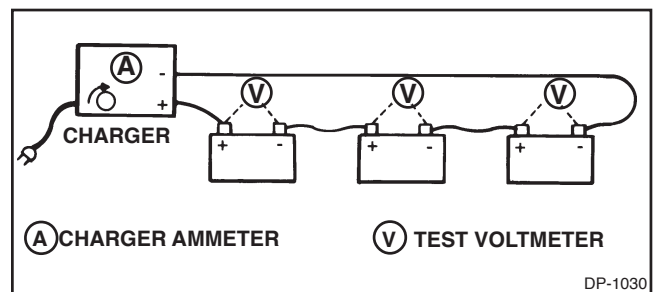

Figure 1.

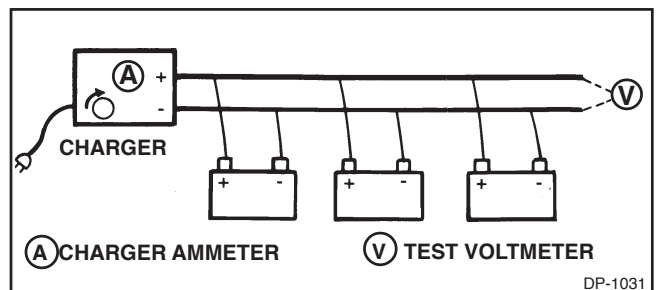

Figure 2.

To prevent undercharging or overcharging and battery damage on the charging rack, the following procedures are recommended:

NOTE

The recommendations following are for batteries whose electrolyte and plates are at room temperatures of 55°-85°F (13°-30°C). Extremely cold batteries accept very little charging current and will not conform to the suggested procedures.

5-3. Group Charging on Current-Limiting or Series Chargers

1. Visually inspect all batteries for cracked covers or cases; replace obviously damaged batteries.
 - A. Filler-cap batteries: Check with hydrometer. If reading is 1.230 or more, test as outlined in Delco Service Bulletin 1B-115. If reading is below 1.230, proceed with charging procedure. If fluid level is low, add water to bring level sufficiently high for hydrometer readings, but not to the split ring, then proceed with charging. After charging, add water just to split ring.
 - B. Freedom batteries: Check built-in hydrometer; if clear or yellow, replace the battery. If hydrometer has a green dot, do not charge, but test as outlined in Delco Service Bulletin 1B-116. If hydrometer is dark, proceed with charging procedure.
2. Connect batteries to charger as shown in Figure 1. Do not exceed the charger's voltage capabilities by connecting too many batteries. Make sure all connections are clean and tight. Set charging rate within 5-10 ampere range and maintain this charging rate throughout the charging procedure.
3. After two or three hours of charging, check batteries as follows:
 - A. Filler-cap batteries: Take hydrometer readings at hourly intervals. Correct readings to 80°F (27°C). Remove any battery from charge when there is no increase in specific gravity after three successive hourly readings. Any battery that becomes hot (125°F, 52°C), or violently gasses, should be removed from the charger for testing. Readjust control to maintain same charging rate after the batteries are removed.
 - B. Freedom Batteries: Check for green dot indication. Shake or tilt batteries at hourly intervals to see if green dot will stay visible. Also check terminal voltage of each battery with test voltmeter connected, as shown in Figure 1. While on charge, if voltage across battery is 16.0 volts or more, or if green dot appears, remove battery from charger. Any battery that becomes hot (125°F, 52°C), as determined by touching and feeling the case, or any battery that violently gasses, should be removed from the charger for testing. Readjust control to maintain same charging rate on remaining batteries as charged batteries are removed.
4. After charging, all batteries should be tested as described in the testing procedure in Delco Service Bulletins 1B-115 or 1B-116 to make sure batteries are good and usable.

5-4. Group Charging on Voltage-Limited or Parallel Chargers

1. Visually inspect all batteries for cracked covers or cases; replace obviously damaged batteries.
 - A. Filler-cap batteries: Check with hydrometer; if reading is 1.230 or more, test as outlined in Delco Service Bulletin 1B-115. If reading is below 1.230, proceed with charging procedure. If fluid level is low, add water to bring level sufficiently high for hydrometer readings, but not to split ring, then proceed with charging. After charging, add water to split ring.
 - B. Freedom batteries: Check built-in hydrometer; if clear or yellow, replace battery. If hydrometer has a green dot, do not charge, but test as outlined in Service Bulletin 1B-116. If hydrometer is dark, proceed with charging procedure.
2. Connect batteries and test voltmeter to charger as shown in Figure 2. Make sure that all connections are clean and tight. Set charging voltage setting to a setting that does not exceed 16.0 volts. The charger may not be able to reach this voltage initially, but as batteries become charged and accept less current, the voltage will rise. The ammeter of the charger is indicating the total current flow to the connected batteries. This current divides into the various batteries. It is not a measure of each battery's current acceptance. Do not exceed the charger's capabilities by connecting too many batteries. Follow the charger manufacturer's directions.
3. After two or three hours' charging, check batteries at hourly intervals as follows:
 - A. Filler-cap batteries: Take hydrometer readings at hourly intervals. Correct readings to 80°F (27°C). Remove any battery from charge when there is no increase in specific gravity after three successive hourly readings. Any battery that becomes hot (125°F, 52°C), or violently gasses should be removed from the charger and tested. In the event that a hot battery is removed, most of the charging current was going to that battery and it will be necessary to continue charging the remaining batteries since they received very little charging current.
 - B. Freedom batteries: Check for green-dot indication. Remove from charger when green dot stays visible. Any battery that becomes hot (125°F, 52°C), as determined by touching and feeling the case, or violently gasses, should be removed from the charger and tested. In the event that a hot battery is removed, most charging current was going to that battery and it will be necessary to continue charging the remaining batteries, since they received very little charging current. Readjust control to keep voltage below 16.0 volts if necessary, as batteries are removed.
4. After charging, all batteries should be tested as described in the testing procedure in Delco Service Bulletins 1B-115 or 1B-116 to make sure batteries are good and usable.

5-5 Heavy Duty Diagnostic Procedures Data

Section 3-7 BATTERY CABLE TEST

W/500 AMP LOAD (FROM FIGURE 3-3)

POSITIVE CABLE LOSS			NEGATIVE CABLE LOSS			NEGATIVE CABLE LOSS
	V4	+		V5	+	
<hr/>						(MAX. 0.500 V)

Section 3-15. 3-16 STARTER SOLENOID CIRCUIT TEST

W/100 AMP LOAD (FROM FIGURE 3-6)

FIRST WIRE LOSS			SECOND WIRE LOSS			MAG SWITCH LOSS		TOTAL SOLENOID CIRCUIT LOSS
	V9	+		V10	+		V11	=
<hr/>								(MAX. 1.00 V)

Section 3-27 ALTERNATOR WIRING LOSS

AMP LOAD = ALTERNATOR RATED OUTPUT (FROM FIGURE 3-8)

POSITIVE CIRCUIT LOSS			NEGATIVE CIRCUIT LOSS			ALTERNATOR CIRCUIT LOSS
	V24	+		V25	+	
<hr/>						(MAX. 0.500 V)

(AMP LOAD AND MAXIMUM VOLTAGE LOSSES SHOWN ARE FOR 12V SYSTEMS.)

Delco Remy is a registered trademark licensed by General Motors Corporation.



Diagnostic Procedures Manual

Delco Remy
2902 Enterprise Drive
Anderson, IN 46013 U.S.A.

www.delcoremy.com

For Customer Support call:
1.800.372.0222

