



Lloyd's Register Technical Association

MICROBIAL ATTACK ON SHIPS AND THEIR EQUIPMENT

by

R. A. Stuart

Paper No. 4 Session 1994-95

The author of this paper retains the right of subsequent publication, subject to the sanction of the Committee of Lloyd's Register of Shipping. Any opinions expressed and statements made in this paper and in the subsequent discussions are those of the individual and not those of Lloyd's Register of Shipping.

Written contributions to the discussion of this paper are invited from members of the Lloyd's Register Technical Association. To ensure inclusion in the discussion paper, the contributions should be received by the Hon. Secretary in London not later than 7th April 1995.

Hon. Sec. S. S. Dhanjal
71 Fenchurch Street, London, EC3M 4BS

MICROBIAL ATTACK ON SHIPS AND THEIR EQUIPMENT

by

R. A. Stuart



Richard Stuart was an Engineer Cadet with BP Shipping and attended Glasgow and South Shields Engineering Technical College. From 1974-83 he served as a seagoing Engineer Officer and then as a Technical Engineer and Superintendent Engineer Assistant. After leaving BP Shipping in early 1986, further engineering positions included UK Service Manager of Alfa-Laval Engineering, Administration Superintendent in Sealink British Ferries and General Manager, After Sales Division of Fisher Controls. He joined Lloyd's Register of Shipping in the later part of 1990 as an Engineer Surveyor within the Fluid Analytical Consultancy Services (FACS) Department. He is responsible for the development of the Lubricant Quality Scan (LQS) section and involved in operational investigations and analytical consultancy support to the marine, offshore industry and industrial sectors.

TABLE OF CONTENTS

SYNOPSIS

1. INTRODUCTION

2. MICROBES

- 2.1 Types of Microbes
- 2.2 Sources of Microbial Contamination
 - 2.2.1 Seawater
 - 2.2.2 Refinery practices
 - 2.2.3 Onboard
- 2.3 Symptoms of Microbial Contamination

3. SYSTEMS AFFECTED BY MICROBIAL CONTAMINATION

- 3.1 Fuel Oil
- 3.2 Lubricating Oil
- 3.3 Cooling Water
- 3.4 Bilge Water
- 3.5 Ballast Water
- 3.6 Distillate Cargoes

4. PREVENTION AND ELIMINATION OF MICROBIAL CONTAMINATION

- 4.1 Prevention
 - 4.1.1 Physical Prevention
 - 4.1.2 Chemical Prevention
- 4.2 Elimination
 - 4.2.1 Physical Decontamination
 - 4.2.2 Chemical Decontamination
- 4.3 Alternative Strategies

5. HEALTH CONSIDERATIONS

- 5.1 Microbial Hazards
- 5.2 Risk Assessment and Risk Avoidance
- 5.3 Biocide Chemicals
- 5.4 Test Kit Disposal

6. CASUALTIES

- 6.1 Human Casualties of Microbial Contamination
 - 6.1.1 Drinking Water
 - 6.1.2 Domestic Water
 - 6.1.3 Air Conditioning
 - 6.1.4 Sewage treatment
- 6.2 Marine Casualties of Microbial Contamination

7. TESTING FOR MICROBIAL PRESENCE

- 7.1 Onboard Test Kits
- 7.2 Sampling Procedures
- 7.3 Interpretation of Results

8. STANDARDS

9. CONCLUSION

10. ACKNOWLEDGEMENTS

11. REFERENCE & BIBLIOGRAPHY

APPENDIX A

Microbial contamination questionnaire

SYNOPSIS

This paper addresses the microbial problems being faced by the marine industry which have reached almost epidemic proportions. The industry is now witnessing severe corrosion not only in ballast tanks and bilges, but often in other areas which are least expected.

Microbial contamination is encompassing fuels, lubricants, bilge and ballast water, often causing severe damage to hull, machinery and equipment. Ship board contamination may be initiated from previously infested tanks and systems, or be introduced onboard through contaminated fuel or seawater. Poor housekeeping methods, environmental legislation and ship design are all conducive to microbial proliferation and its associated problems.

Far from being an 'act of God', microbial damage is almost entirely manmade and preventable; consequently hull insurance is often refused for coastal trade and inshore work boats, unless appropriate anti-microbial preventative procedures are implemented.

The research conducted by Fluid Analytical Consultancy Services (FACS), examined the ways in which microbial contamination can be reduced by implementing controls, good housekeeping and chemical biocides. To achieve this, new standards are suggested to monitor these measures, thus ensuring that the safe operation of ships is not jeopardised and human health is not endangered.

1. INTRODUCTION

Technical operational problems in marine machinery seem to run in cycles; for example, high cylinder liner and piston ring wear in the early days of the use of residual fuel, tin corrosion of turbine bearings in the Sixties, and the structural problems affecting bulk carriers, tankers and Ro/Ro vessels. As answers are found, so the problems decrease and in some cases are never heard of again.

Microbiological attack on distillate fuels and lubricants seemed to be at its height in the Seventies and early Eighties and a large number of ships were affected. As the marine industry found out more about the causes so the industry was able to effect remedies. Normally, once a cycle has peaked the problem is virtually over. To some extent this has been true with microbial attack on lubricants, but it has not been totally eradicated. While microbial problems in the marine industry were originally mainly confined to distillate fuels and lubricants, recently the areas of attack have spread to residual fuels, bilge, ballast, and potable water.

Curious though this appears on a preliminary examination, there are in fact several reasons for this sudden upsurge:

1. Lower levels of shipboard manning and less experienced personnel have proved a fatal combination for maintaining stringent housekeeping.
2. Adverse trading conditions have led to ships being laid up or in intermittent service, providing long, undisturbed incubation periods for opportunist microorganisms.
3. Somewhat ironically, marine pollution legislation under the MARPOL 73/78 regulation which restricts the pumping of bilges, has led to water laying stagnant for longer periods.
4. Environmental restrictions in the use of toxic biocidal chemicals within bilges and fuels, exacerbates the problems associated with microbial contamination.
5. Design considerations of tanks, bilges and pipe systems should provide effective water draining and subsequent treatment.
6. Lack of knowledge of the factors which cause microbial contamination and accurate diagnosis of the operational problems being experienced.

Consideration of these factors, as well as explaining the increase in corrosion problems, also identifies how strategies for recognition, evaluation, rectification and control of microbial infestation may be implemented.

The intention of this paper is to introduce microbiological problems which Surveyors may encounter. In this respect, each section of the paper has been laid out for ease of reference. The main microbial processes are introduced in Section 2. These processes are related to the systems employed onboard ships in Section 3, and Section 4 deals with the methods currently applied to controlling microbial infection. The effects of microorganisms on human health and the potential casualties are discussed in Sections 5 and 6 respectively. Guidance is given for onboard identification of microbial problems in Section 7. Finally, the applicable standards are provided in Section 8.

It is not intended that this paper provides a comparison of the seriousness of this form of deterioration of ships and their equipment with that of other corrosion deterioration processes. This would form the object of a future paper when the appropriate data is available to allow comparisons to be made. In this respect, it would be necessary to determine the cause of any corrosion deterioration of ships and their equipment. It may be that corrosion deterioration previously assumed to be electrochemical was in fact microbiological.

2. MICROBES

Whilst even the worst marine oil spills are eventually broken down by microorganisms, few of us appreciate that the same microbes are equally content onboard.

The microbiological contamination process is a well known phenomenon and small populations of microorganisms exist quite naturally. These microorganisms, consisting of bacteria, yeasts and moulds, are easily tolerated at low contamination levels. It is only when their numbers are not controlled within their immediate environment, that they experience rapid growth, resulting in infestation.

A good example is food, which when past its 'sell by date', quickly spoils as the natural resident microorganisms multiply uncontrollably, particularly under warm conditions.

From a marine point of view there are six main areas of concern for microbiological infestation. These are:

1. Distillate fuel;
2. Lubricating oil;
3. Cooling water;
4. Bilge water;
5. Ballast water;
6. Distillate cargoes.

In each case, it is to be remembered that microbes are living organisms and their growth depends upon the readily availability of water, nutrients, heat, oxygen (or sometimes lack of it) within an otherwise acceptable environment.

Water: The main requirement for microbial proliferation is water. This is indicated in the majority of fuel and lubricant microbial problems reported, which identified the presence of water within the storage and service tanks due to infrequent draining. In the laboratory, using selected microbes, an aqueous nutrient supplement and an ideal temperature at about 30°C, visible growth will be present within about a week. Although adequate water is supplied under laboratory conditions, in practice, water availability is often growth limiting.

Whilst water dissolved in fuel appears to sustain slight mould growth, it is generally believed that microbes in the fuel phase are resident in water droplets or surrounded by a water sheath.

Substantial microbial growth needs substantial free water, probably more than 1% - wt.content.

It should be noted that water *availability* is the key factor and not water *concentration*; a solute such as glycol antifreeze additive which migrates from the fuel to the water, depresses the relative humidity (water activity) and water becomes less available for microbial growth.

The same principle controls microbial spoilage of jam – the sugar depresses the water activity. Also, some aviation fuel specifications include glycol additives both to prevent water freezing and to suppress microbial growth. The more antifreeze that is present, the greater the anti-microbial effect and typically, 0.15% - wt.content is required in fuel specifications. Traces of weak glycol solutions in water are growth stimulating, thus overdosing with glycol is preferred as a safeguard against contamination.

Modern lead-free gasolines contain water soluble oxygenates such as methyl and ethyl alcohol, methyl tertiary butyl ether and it seems likely that these are also anti-microbial, when they migrate to a water phase in sufficient concentration.

Nutrients: All microorganisms require equitable conditions for their nourishment and growth. Hydrocarbons and chemical additives in the fuel and lubricant act as their food source,

coupled with those that are also available from contaminated water sources. It seems that whether the latter is salt or fresh water makes little difference to the microbes, except that the sulphate in seawater is readily converted to hydrogen sulphide by Sulphate Reducing Bacteria (SRB). Polluted harbour water used to wash and ballast tanks will probably contain nutritive organic matter and agricultural fertilisers, as well as fuel degrading microbes – a legacy of years of oil pollution.

In cargoes, traces of previous shipments of urea, fertiliser and possibly sugar may add nutrients to the microbes' diet. In addition, low concentrations of most biocides are growth promoting, not growth inhibiting. Rust and other particulates also seem to stimulate microbial growth. As in the cycle of life, dead microbes feed living ones.

However, ideal conditions for microbial growth do not normally occur in practice. The relatively rapid growth which can be achieved in the laboratory in one week will take longer, probably several months, under shipboard conditions. Severe corrosion, if it occurs, will not appear for many weeks after growth has become apparent. Clean, dry, low temperature fuel will never permit significant growth of microorganisms.

Temperature: Is a vital factor; warm conditions encourage growth, whilst extreme cold below 5°C and excessive heat above 70°C will inhibit the most hardened of microbes. They prefer a temperate climate, in the temperature range of 15°C to 35°C. Warm engine rooms provide ideal breeding grounds.

Environment: Corrosive species of microbes dislike undue agitation, preferring the fuel and lubricant systems to lie dormant. Laid-up ships, or ships in intermittent service, are the most vulnerable to attack. Any condensation or water leakage completes the required environmental conditions for microorganism proliferation, since they live in a water phase, but feed off nutrients within an oil phase. Hence, the oil/water interfaces are particularly susceptible to infection. The unpleasant by-products of their digestion, after hydrocarbons have been oxidised into acids, include toxic and pungent hydrogen sulphide. This is produced from any sulphurous compounds within the fuel, lubricant, seawater or waste product. Microbial growth is seen as a characteristic sludge formed from accumulated cellular material which may restrict fuel and lubricant pipe lines and filters.

Given the ideal environment, a small number of microbial cells can multiply to produce a few kilograms of biomass in a very short period.

Microbes can flourish over a wide range of physical conditions. Some can be found growing slowly in the refrigerator, whilst others exist in hot springs. One group can exist at pH 1, while others at pH 10. It should not be inferred that any one species can flourish over a wide range of physical conditions, as each species has its own well defined set of optimal conditions.

2.1 Types of Microbes

Microbiological contamination and growth can have a significant impact upon the safe and efficient operation of ships. In many instances, problems which were fundamentally microbial in nature have not been recognised as such, especially when microbial infection was only partly to blame for the phenomena experienced.

There is no doubt that the marine industry continues to lag behind other major industries in its appreciation of the consequences of microbial infection, particularly those infections which have involved distillate products. The experience gleaned from the detection, quantification and cure of infec-

tion in other industries can still be applied in principle, but there are a variety of additional factors unique to the marine industry.

In the problems of the marine industry, three basic types of spoilage and corrosive microorganisms are identified; **bacteria, yeasts and moulds.**

Bacteria can be further subdivided into three main types:

1. Aerobic Bacteria
Require oxygen to survive.
2. Anaerobic Bacteria
Live in the absence of oxygen
3. Facultative Bacteria
Live with or without oxygen

Bacteria: are a very diverse group of simple, single celled organisms with a rigid cell wall. Bacteria may be rod-like, spherical or spiral in shape and typically range from 1 to 5 μm in size. Many bacteria are actively mobile and can move through a liquid medium using a whip-like appendage or flagellum. They are able to reproduce asexually and rapidly by binary fission, into two cells, often with a doubling time of less than twenty minutes, as shown in Figure 2.1.



Figure 2.1 Bacteria reproducing by binary fission

This allows them to exploit any good growth conditions. Some types produce spores which are resistant to adverse conditions such as disinfectants and temperatures. They may grow aerobically (with oxygen) and/or anaerobically, (without oxygen) using both simple and complex nutrients. Their great diversity means that virtually any organic substance can be utilised by one or more types of bacteria, as shown in Figure 2.2.

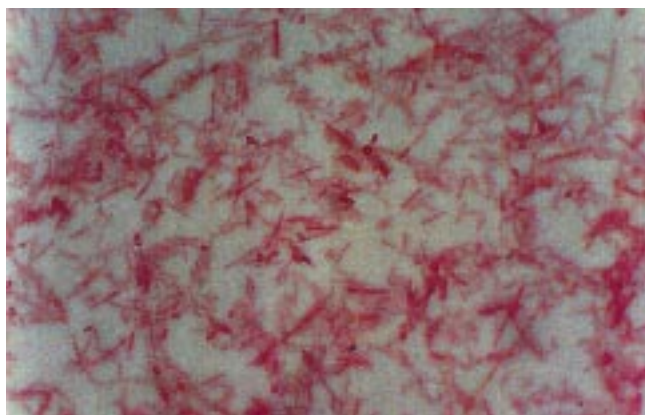

Figure 2.2 Uncontrolled bacteria proliferation

Although in general, they prefer neutral or slightly alkaline conditions, some species are very acid tolerant. Partial breakdown products are a common feature, being secreted out of the cell and such partial breakdown products serve as nutrients for other microbes. This leads to the rapid development of a consortium of species able to biodegrade the substrate, being interdependent upon each other for nutrients or environmental modification. Many types produce copious amounts of extra-cellular slime material, which aids their attachment to surfaces and also protects the colony from changes in the environment. In particular, slimes may deactivate, or prevent diffusion of chemical biocides into the bulk of the slime, thus reducing the effectiveness of this form of remedial treatment. Even a thin slime layer prevents diffusion of oxygen to the base of the slime, and this, coupled with the demand for oxygen by the aerobic bacteria, leads to ideal conditions for the growth of SRB and associated corrosion problems. Typical bacteria known to utilise hydrocarbons are *Pseudomonas aeruginosa*, other *Pseudomonas species*, *Flavobacterium spp.*, *Acinetobacter spp.*, *Alcaligenes spp.*, *Micrococcus spp.*, *Arthrobacter ssp.*, *Corynebacterium spp.*, *Brevibacterium spp.*, *Klebsiella spp.*,

Yeasts: are unicellular, being ovoid or spherical in shape and about 5 μm long however, some may also produce rudimentary filaments, as shown in Figure 2.3.

They reproduce by budding on the parent cell, increasing in size and eventually separating. The reproduction cycle takes several hours to complete and they prefer slightly acidity conditions. Typical yeasts growing on hydrocarbons are *Candida spp.*, *Saccharomyces spp.*, *Torula spp.*, *Torulopsis spp.*, *Hansenula spp.*

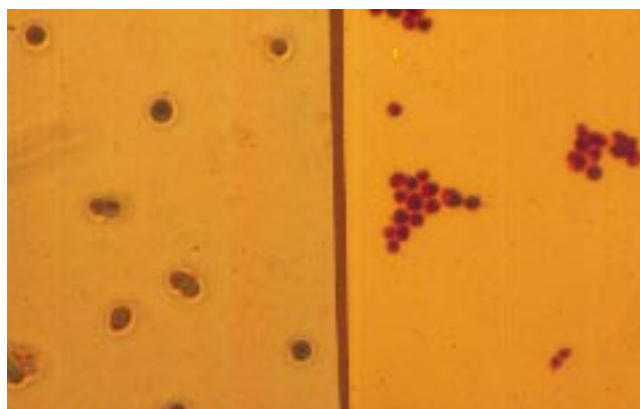

Figure 2.3
Ovoid and spherical yeast isolated from contaminated fuel oil

Moulds: are typically multicellular, with rigid, chitinous cell walls. They usually grow in the form of branched hyphae, a few microns in diameter, to form extensive, thick, tough, intertwined mycelial mats, especially at interfaces, as shown in Figure 2.4.

Growth is brought about through the simultaneous filament lengthening and the production of branches. The reproduction cycle to double their size lasts only a few hours, unless there are problems in nutrient diffusion to the centre of the coherent mat, then rapid growth is confined to the periphery. Eventually, spores are produced which disperse and germinate to produce new growth mats, preferring slightly acid conditions. They produce many oxidised carbon

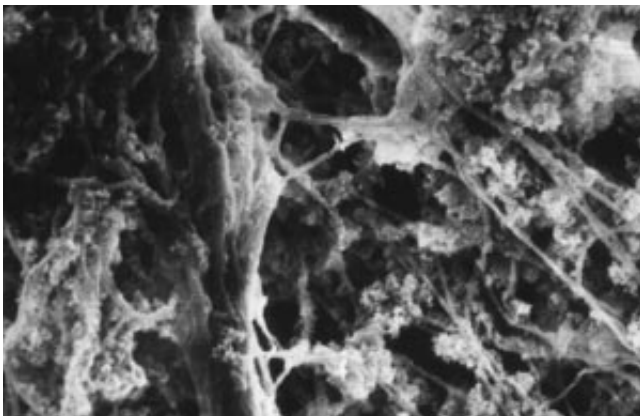
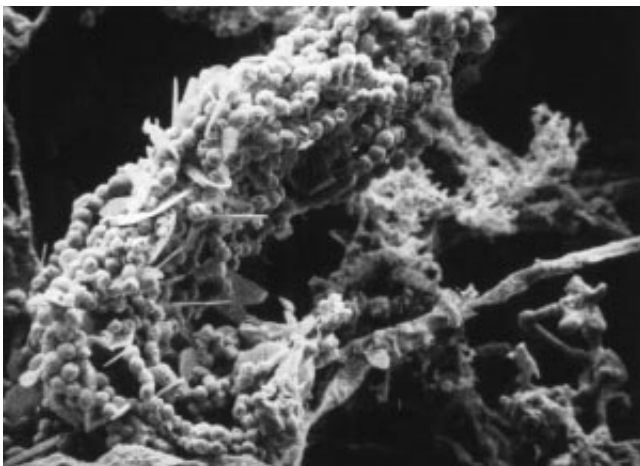
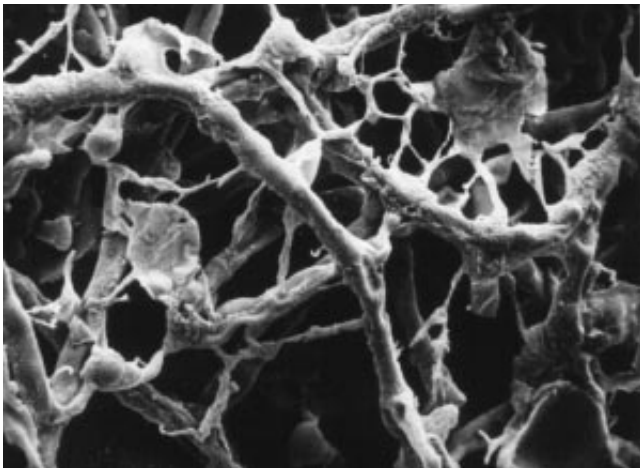

Figure 2.4
The formation of extensive, thick, tough, intertwined mycelial mats by stages

compounds, especially low molecular weight compounds such as organic acids, which can be used by other microbes. Their demand for oxygen again creates ideal conditions for the growth of SRB. Typical moulds which degrade hydrocarbons are *Penicillium spp.*, *Aspergillus spp.*, *Fusarium spp.*, *Monilia spp.*, *Botrytis spp.*, *Cunninghamella spp.*, *Scopulariopsis spp.*

Sulphate Reducing Bacteria (SRB): are a specific group of anaerobic bacteria that have special growth requirements. They only use simple carbon sources, not hydrocarbons, require the activity of other microbes in a consortium and

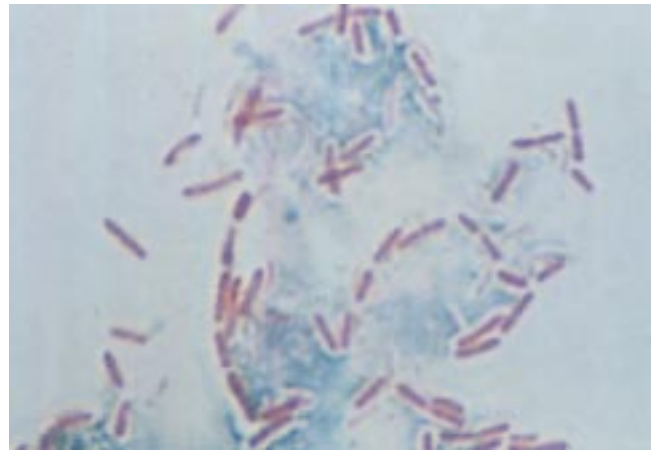

Figure 2.5
SRB under the microscope compared to 5µm in size

produce hydrogen sulphide by reduction of oxidised sulphur-containing compounds, such as sulphate from seawater, as shown in Figure 2.5.

They are involved directly with many microbial corrosion reactions and can cause sulphide souring of stored distillate products. Typical SRB are *Desulfovibrio spp.*, *Desulfotomaculum spp.*, *Desulfobulbus spp.*

Overall, the microorganisms which are identified most often in the marine industry, are the hydrocarbon degrading spoilage and corrosive species, as indicated in Figure 2.6.

The moulds tend to form a coherent mat under which intense corrosion can occur. Two types of moulds *Cladosporium resinae*, now renamed *Hormoconis resinae* and *Aspergillus fumigatus* which can tolerate seawater and higher temperatures, were previously known as being the most troublesome,

**Gram-negative.
Spoilage Species.**

Bacteria (aerobic);
Pseudomonas aeruginosa.
Pseudomonas fluorescens
Pseudomonas cepacia.

Yeasts;
Candida spp.
Saccharomyces spp.
Torula spp.

Moulds;
Cladosporium resinae/ Hormoconis resinae.
Aspergillus fumigatus.
Fusarium oxysporum.

**Gram-negative.
Corrosive Species**

Bacteria (anaerobic)
Desulfovibrio desulfuricans.
Desulfotomaculum spp.
Desulfobulbus spp.

Gram-positive.

These microorganisms are not normally the cause of problems in the marine industry.

Figure 2.6 Spoilage and corrosive species

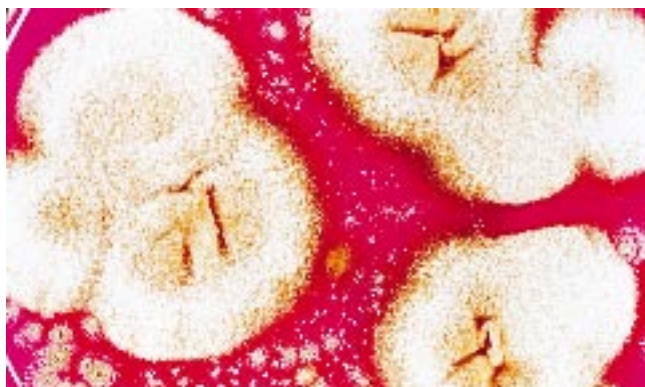

Figure 2.7
Cladosporium resinae mould taken from contaminated fuel oil



Figure 2.8
Filter debris, showing rod-shaped bacteria, branched moulds, fungi and yeasts

as shown in Figure 2.7. Today, responsibility is shared between a very broad spectrum of bacteria, yeasts and moulds, as shown in Figure 2.8.

The aerobic bacteria *Pseudomonas spp.* have the ability to utilise a wide range of substrates for their growth and can cause considerable surfactancy problems, in the presence of dissolved oxygen. Only a few ppm of dissolved oxygen is required to sustain microbial growth. Depletion of oxygen then serves to encourage the growth of anaerobic bacteria.

There are several genera of dissimilatory anaerobic bacteria known as Sulphate Reducing Bacteria (SRB). Two of the most important are *Desulfovibrio spp.* and *Desulfotomaculum spp.* The latter has the ability to produce resistant spores, which can tolerate prolonged exposure to air and can survive the application of many biocides currently available.

Both of these particularly insidious strains of SRB are highly dangerous and in their most virulent form, will quickly corrode hull, machinery and equipment.

2.2 Sources of Microbial Contamination

Operational problems due to microbial contamination may be due to imported infested hydrocarbons and seawater, previous onboard contamination, a combination of both or result from poor onboard operational procedures.

2.2.1 Seawater

Oceans usually contain less than 10^3 bacteria per cm^3 and negligible quantities of yeasts and moulds. Only 0.1% of these bacteria will be hydrocarbon degrading and SRB is even rarer. However, seawater confined in harbours and estuaries with a long history of oil spillage, oil tank and sewage discharges will contain far in excess of 10^3 bacteria per cm^3 , including hydrocarbon degraders and large numbers of SRB. Additionally, phosphorus and nitrogen pollutants from agricultural fertilisers, plus corrosion inhibitors and oil additives, will ensure that sufficient nutrients are present to nourish SRB. Consequently, harbour and estuary seawaters which might contain up to 11 ppm of nitrogen and 2 ppm of phosphorus, are far more nutritious to rapacious microorganisms than the water in the oceans, which would not contain more than 1 ppm of nitrogen and phosphorus.

2.2.2 Refinery Practices

Recent years have seen a dramatic increase in contaminated distillate fuel oils being supplied. This is then compounded by poor housekeeping standards at bunkering facilities.

Controls: Poor quality control standards and relaxed housekeeping at refineries, tank farms and delivery barges can be responsible for fuel contamination. Recently, imported infected gas oil cargoes from Eastern Europe have been distributed for use on ships. In many cases, the contamination was detected before being used onboard and was successfully counteracted with heat, filtration and biocidal treatment. However, not all ships were so fortunate.

Storage: Another source of microbial contamination is introduced when shore storage tanks are cleaned and washed using polluted river water. This will not only introduce fuel adapted microbes but also vital nutrients, particularly nitrogen and phosphorus. However, it does not mean that tanks which are infected will always deliver 'unfit for use' contaminated fuel. Microbes aggregate at the fuel/water interface but are readily dispersed in the fuel by modest agitation; they have a specific gravity of about 1.05, and settle slowly back to the interface. Fuel drawn from the top of an infected but undisturbed tank will be reasonably clean. Conversely, if the draw off is taken by floating suction during a fast delivery when the tank level is low, this will result in heavily contaminated fuel. The outcome could be severe operational problems within a few hours of using the infected fuel, as shown in Figure 2.9.

Floating roof storage tanks usually permit some water ingress through the seals. In a polluted atmosphere this may carry in nutrients. Even if a floating roof tank is empty it should still be regularly drained and manholes should not be left open. This admits light, allowing algae to flourish and hence builds up a food chain for microorganisms. Fuel residues in the tank complete the nutritious environment. Should storage tanks be left empty for long periods, they may need decontamination before re-use.

Process: The major factors contributing to the increase in microbial problems in the marine industry, are due to changes in the fuel supply.

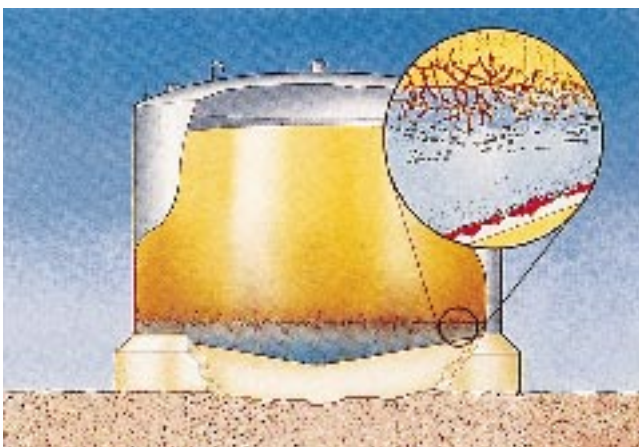
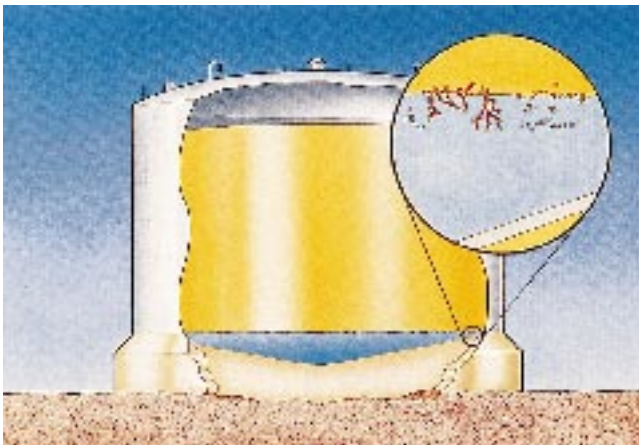
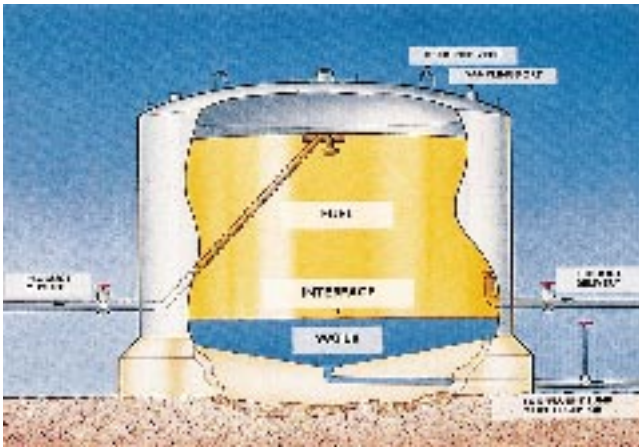

Figure 2.9
Storage tank microbial contamination resulting in growth proliferation, corrosion products and deterioration of fuel quality

1. Changes in base oils, refining and blending; the size, saturation and configuration of hydrocarbon molecules influences their biodegradability.
2. Changes in the type and range of fuel additives; these frequently contain nitrogen and phosphorus, vital elements for growth.
3. Changes in product handling and distribution; faster throughput permits less time for particulates and water to settle and, at the refinery, less time for the product to cool. This has exacerbated the problem by making the fuel more nutritious to contaminating microbes.

Fuel oils have so far only experienced heavy infection in gas or diesel oils of the distillates. The higher incidence of contamination in distillates is no doubt due to the predominant molecular types. Black distillates are all the more vulnerable due to the abundance of trace elements emanating from quantities of residual fuel and the cutterstock used during blending.

It is quite a common occurrence for sulphides to be produced by the activities of SRB whenever wet fuel is stored or transported. Present in the water phase, SRB activity is stimulated in the presence of fuel oil and contaminated water. This activity occurs when hydrocarbon degraders create the anaerobic conditions, acid and alcohol food sources, and shift the overall pH value of the oil/water phase necessary for SRB proliferation.

2.2.3 Onboard

Operational problems relate to the hazards in various systems onboard, but full consideration should first be given to the source of contamination.

Bilges: Polluted waters and a continuous supply of hydrocarbons into bilges which may not always be pumped dry, all contribute to microbial problems. SRB activity is clearly evidenced in high rates of corrosion and tends to be localised around specific areas, forming pits and eventually holes.

Fuel Oil: There will always be an initial source of shipboard fuel contamination such as a shore tank, a dirty pipe line, road tanker or polluted tank wash water. Airborne contamination via tank breathers is less likely. Once infestation has occurred, particular circumstances may encourage microbial proliferation onboard. Further inoculation is then immaterial as the key aggravating factors are water and warmth.

Water accumulates in tanks when there is no drain or water scavenge system, where the drain is not at the lowest point in the tank and where draining procedures are not enforced.

Tanks in the engine room or other warm locations and tanks receiving recirculated distillate fuel from injectors, are ideal to incubate microbes, as shown in Figure 2.10.

The double bottom tanks due to the lower temperatures are less prone to microbial proliferation.



Figure 2.10
Sulphate reducing bacteria corrosion of fuel injectors

Lubricating Oil: Lubricant operating temperatures of crankcase oils in wet engines are normally sufficient to control and prevent infestation. Any problems are usually associated with ships which have shut down their lubricant system, allowing temperatures to drop and water to accumulate.

Microbial growth in mineral hydraulic oil systems are prone to attack. This is due to the operation of the system generating heat and the bulk temperature will then probably be high enough to stimulate microbial growth. If air is entrained, oxygen will dissolve according to its partial pressure and aerobic microbial growth will be sustained, as shown in Figure 2.11.

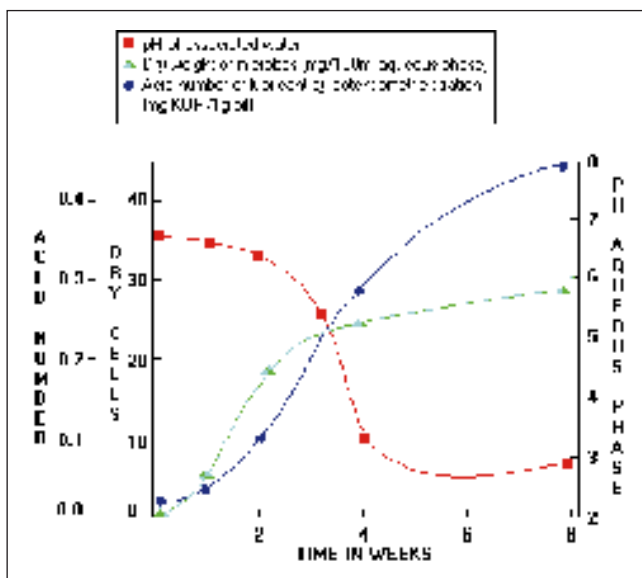

Figure 2.11
Changes in hydraulic oil due to growth of microorganisms

Microbes are not inhibited or destroyed by the range of pressures in common use. It is also possible that they can contribute to cavitation damage by acting as bubble nuclei.

Controllable pitch propeller hydraulic oil systems have been particularly vulnerable to microbial spoilage and fouling problems. This has resulted in biocides being incorporated within the hydraulic oil formulation, as shown in Figure 2.12.



Figure 2.12
Microbial slime in hydraulic oil system

2.3 Symptoms of Microbial Contamination

Functional operational problems are commonly encountered after severe infestation by microbes, following early warning signs. This enables preventative and successful remedial measures to be undertaken. The visual and operational warning signs of hydrocarbon and bilge/ballast water infection, which although individually may be ascribed to other causes, should in combination alert the marine engineer to a potentially hazardous situation, as illustrated in Figure 2.13.

Fuel Oil: When heavily infected fuel is used, all or some of the phenomena listed in the symptoms of microbial contamination, will confront the engineer within a few hours. In the first case he will probably be faced with filter plugging, fuel starvation, injector fouling and, if coalescers are in use, they will malfunction. The extent of the contamination must first be established via the following procedure.

1. Clear glass sample bottles rinsed with boiling water should be used to take drain or bottom samples from service, header and storage tanks.
2. Microbial contamination in a sample will be apparent as a haze in the fuel from the presence of sludge, as shown in Figure 14. This sludge readily disperses in the fuel when the sample is swirled; at this time sticky 'cling film' flakes may be seen adhering to the wall of the bottle. The water will be turbid and there may be some bottom sludge; if this is black, there are SRB present and they will be an added corrosion hazard.
3. The engineer can now evaluate the various fuel locations and instigate an emergency strategy by using the cleanest fuel. If only heavily contaminated fuel is available, it should first be allowed to settle for as long as possible and then drawn off from the top to a clean tank, preferably via a filter, purifier, centrifuge or coalescer. Using a biocide at this stage is usually not advisable due to a tendency to block filters with the dislodged biofilms.
4. At the earliest opportunity, drain or bottom samples should be taken and the supplier's retained sample should be forwarded for microbiological examination. This will identify, by sophisticated 'fingerprinting' if the bunkers supplied were contaminated.

Lubricating Oil: There are many thousands of types of microbes; only a few are able to grow in lubricating oils at the elevated operational temperatures in use. Providing the plant treatment equipment is functional, purifier heater temperature is maintained and the water content kept at a minimum, the lubricating oil system will be both environmentally and nutrient deficient. Such conditions will prevent microbes from establishing themselves. Should heavy contamination of the lubricating oil system occur, this self regulating mechanism will be unable to prevent microbial proliferation. Fortunately, the symptoms of microbial contamination will not occur immediately, allowing the engineer to implement corrective physical and/or chemical decontamination programmes.

Bilge and Ballast Water: Microbial problems in bilge and ballast systems are usually associated with SRB pitting corrosion. In the majority of cases, their presence will be identified visually and by a distinct sulphurous smell. These warning signs of potential problems, should ensure preventative measures are applied in sufficient time to prevent structural damage.

MEDIUM	FUEL	LUBRICANT	BILGE & BALLAST WATER
<i>Visual</i>	<p>Aggregation of microbes into a biomass, observed as discoloration, turbidity and fouling.</p> <p>Biosurfactants produced by bacteria promote stable water hazes and encourage particulate dispersion.</p> <p>Purifiers and coalescers which rely on a clean fuel/water interface, may malfunction.</p> <p>Tank pitting.</p>	<p>Slimy appearance of the oil; the slime tends to cling to the crankcase doors.</p> <p>Rust films.</p> <p>Honey-coloured films on the journals, later associated with corrosion pitting.</p> <p>Black stains on white metal bearings, pins and journals.</p> <p>Brown or grey/black deposits on metallic parts.</p> <p>Corrosion of the purifier bowl and newly machined surface.</p> <p>Sludge accumulation in crankcase and excessive sludge at the purifier discharge.</p> <p>Paint stripping in the crankcase.</p>	<p>The formation of slimes and sludges which are black themselves or are black when scraped.</p> <p>Pitting of steel work, pipes and tank bottoms.</p> <p>Rapid corrosion of plating.</p>
<i>Operational</i>	<p>Bacterial polymers may completely plug filters and orifices within a few hours.</p> <p>Filters, pumps and injectors will foul and fail.</p> <p>Non uniform fuel flow and variations in combustion may accelerate piston rings and cylinder liner wear rates and affect cam-shaft torque.</p>	<p>Additive depletion.</p> <p>Rancid or sulphitic smells.</p> <p>Increase in oil acidity or sudden loss of alkalinity. (BN)</p> <p>Stable water content in the oil which is not resolved by the purifier.</p> <p>Filter plugging in heavy weather.</p> <p>Persistent demulsification problems.</p> <p>Reduction of heat transfer in coolers.</p>	<p>Unusual foul or sulphitic smells.</p> <p>Structural damage.</p> <p>Loss of suction in pipelines.</p>

Figure 2.13
Symptoms of microbial contamination of fuel, lubricants and bilge/ballast water



Figure 2.14
Contaminated fuel oil indicated by its haziness appearance

3. SYSTEMS AFFECTED BY MICROBIAL CONTAMINATION

3.1 Fuel Oil

Microbiological contamination of hydrocarbon distillate fuels (gas oils, rather than residual fuel oils) is a well-recognized problem. The reason for this increase in the marine industry is largely due to changes in the chemistry of distillate fuels and widespread use of fuel additives, some of which stimulates microbial growth.

Composition of Distillate Fuels: Distillate fuel oils such as gas oil, diesel and kerosenes suffer from microbiological attack (oxidation) due to their chemical composition. They contain a wide range of compounds (diesel contains more than 250) but are primarily composed of n-alkanes (50% mostly with carbon numbers between 10 and 18), other straight chain, branched and cyclic alkanes, aromatic hydrocarbons (e.g. benzene, toluene, xylene) in variable proportions up to 25% and polycyclic compounds. The fuel therefore has abundant carbon sources for microbiological growth but is deficient in inorganic nutrients such as nitrogen, phosphorous and potassium. These elements are often the limiting factors in microbial degradation of the fuel and must be supplied from an external source, such as polluted water remaining in shore storage tanks after washing, fuel additives or extraneous water entry into the system.

In fuel, the most readily biodegraded fraction of the fuel is that of the n-alkanes. Under oxygenated humid conditions, complete removal of n-alkanes can take place within a few days. Other compounds may be more toxic or more resistant to attack – for example, alkanes with a carbon number of less than 9 and some aromatics, are highly water soluble and have been shown to resist microbiological degradation. In most cases, however, these compounds can be utilised by one or more microbial groups and will be attacked when physical and/or chemical conditions are favourable. Utilisation of such recalcitrant compounds often occurs after complete biodegradation of the more readily available compounds.

The general chemical formula of the n-alkanes is: $\text{CH}_3(\text{CH}_2)_n\text{-CH}_3$ [simplified to R-CH_3], with carbon atoms arranged in a straight chain. Branching may occur and this generally increases the resistance of the compound to microbiological attack. With straight chain n-alkanes, oxidation occurs by a number of mechanisms which can be represented as indicated;

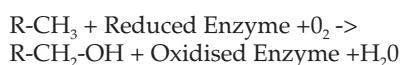

The process requires oxygen and liberates primary alcohols and water. Once microbial oxidation has begun, conditions can be self-perpetuating, with free water and further carbon sources being produced. Other microbial groups are now able to utilise the breakdown products, in turn yielding further carbon compounds as below.

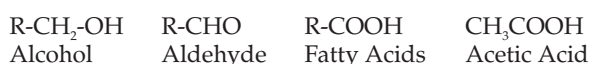

Once conditions are suitable for microbial growth, fuel biodegradation may be rapid, with a diverse and very active microbial flora established in the water phase.

The overall result is that fuels are more nutritious to microorganisms and at every bunkering their food source is replenished. This is particularly evident when water is present during their transportation or storage. During operation,

infestation may arise either with contaminated oil being brought onboard at bunkering, or actually develop onboard. Usually, both factors work in combination. Specific microbes establish themselves in fresh and saline water, and either type may enter fuel storage tanks through condensation or more direct contamination. A relatively small amount can initiate the microbiological process, and this will rapidly accelerate, since carbon, nitrogen, sulphur and phosphorus compounds, which are nutrients to the microorganisms, are all present in distillate fuel. This can produce a varied range of effects which can be directly and indirectly attributable to microbial contamination. The microbiological process is as follows.

Microbiological Process: Until recently, users of fuels seemed better able to accommodate minor degrees of microbial contamination without experiencing operational problems. The reasons are explained as follows:

1. Evolution of microorganism species has now spawned a new type of bacteria in distillate fuels, which produces a sticky polysaccharide polymer, similar to 'cling film'. This rapidly clogs filters and apertures by trapping particulate matter such as rust, as shown in Figure 3.1. As a result, the microbial contamination will be apparent as a haze in the fuel and a grey/brown sludge at the water/oil interface. This polysaccharide polymer by-product is viewed as the most significant factor emerging from contamination problems., as shown in Figure 3.2.



Figure 3.1
Fuel oil filter blockage from clean, initial and severely contaminated by stages

2. Severe microbial activity is also associated with stagnancy, as in long term storage holding tanks, or those with slow turn-over consumption rates such as double bottom tanks. The result is that fuel may be degraded, reducing the hydrocarbon chain length and thereby reducing the fuel's overall calorific value. Furthermore, microbial metabolites such as hydrogen sulphide gas, can cause 'souring' of the fuel. When altering the fuel's hydrocarbon molecular structure, chemical and physical changes are observed affecting the pour point, cloud point and thermal stability, which will be measurably different.



Figure 3.2
Fuel oil microbial spoilage by stages

3. In addition, bacteria which are prolific producers of biosurfactants will after time, establish stable water hazes. The fuel may eventually fail specification tests for water separation. Since coalescers rely on a clean fuel/water interface, equipment malfunction is possible.
4. Where infection is particularly severe and long standing, corrosion may occur. This may be due to the activity of SRB which require oxygen depletion and hence fuel stagnation. SRB produce corrosive hydrogen sulphide which can dissolve in fuel. Additionally, SRB stimulate local corrosion processes by direct sulphide attack and depolarisation of steel surfaces, causing pitting and even complete penetration of tank bottoms. Most microbes, but particularly moulds, produce organic acids, as shown in Figure 3.3. These acids, produced by oxidative attack on the fuel, will lower the phase pH and contribute to corrosion, particularly of copper, aluminium and its alloys, such as bronze, as shown in Figure 3.4.

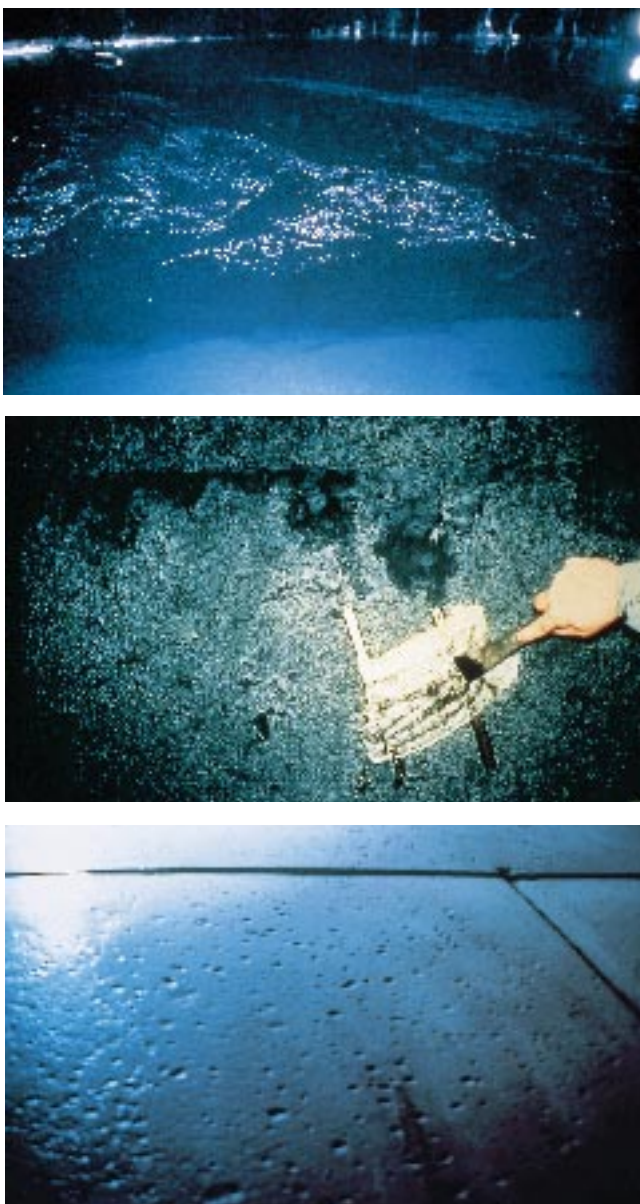

Figure 3.3
Growth proliferation of moulds forming a floating mat, resulting in microbial pitting corrosion

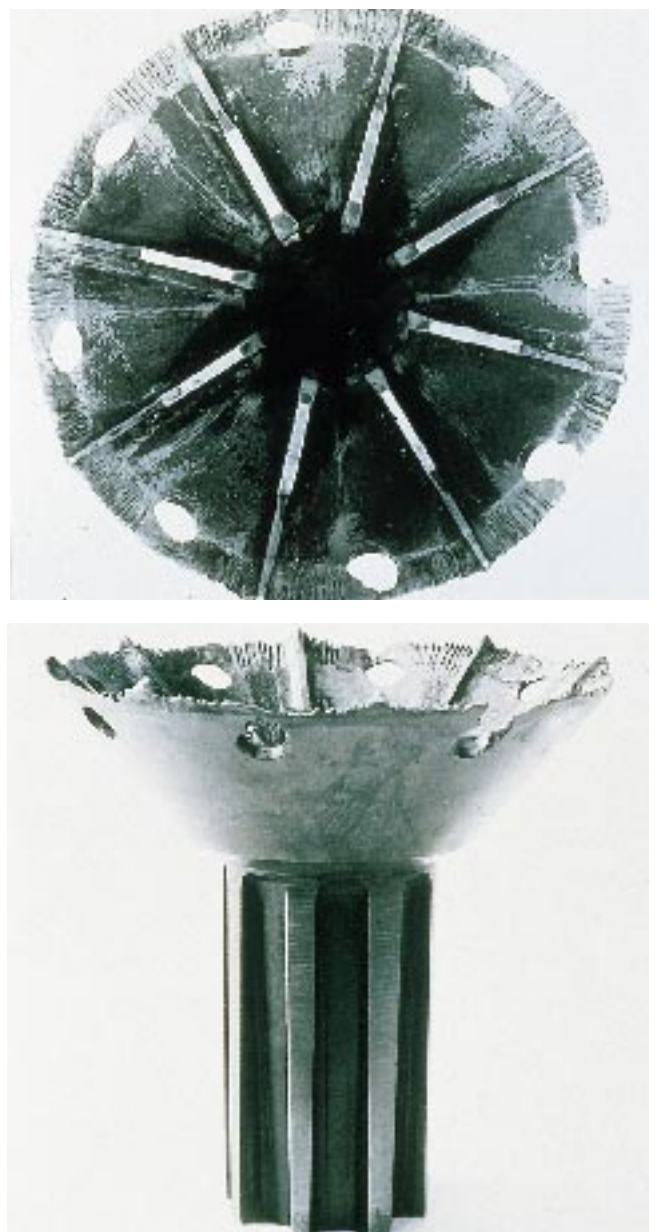

Figure 3.4
Aluminium bronze purifier component eroded by organic acids produced by moulds

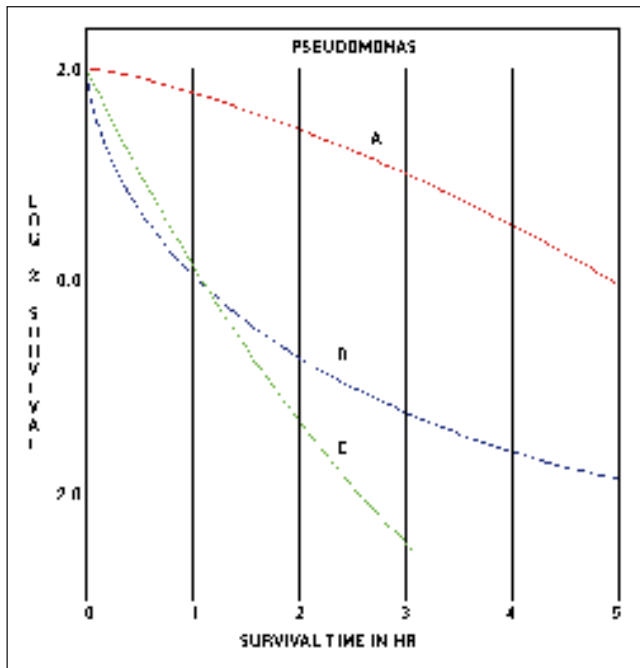

Figure 3.5
Survival rate of three strains of *pseudomonas* spp bacteria in kerosene

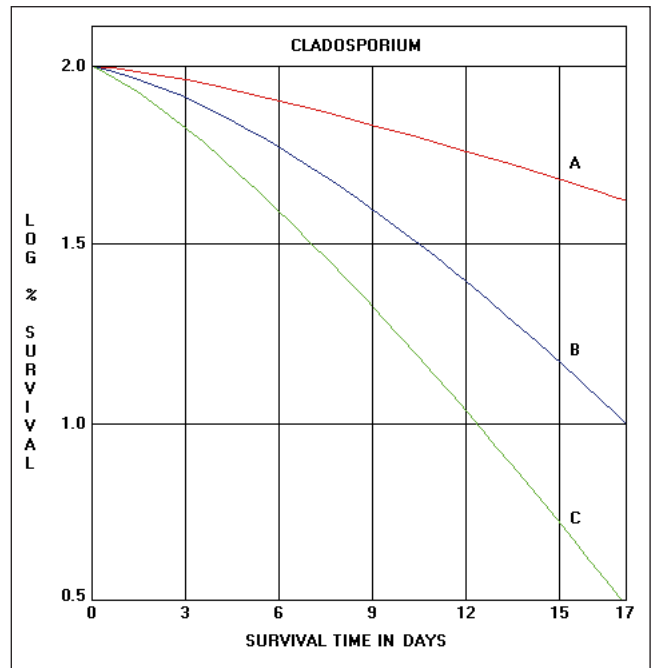

Figure 3.6
Survival rate of three strains of *cladosporium* spp moulds in kerosene

- As well as visual and odoriferous characteristics of contamination, the most common operational problem is filter blocking. Engines running on gas oils and diesel fuels generally have an in-line filter to remove any particulate and/or sludges before the fuel enters the combustion chamber. Aggregation of microbes into biomass causes filters and injectors to foul and ultimately, permanently fail. In turn, the fuel flow is altered and becomes non-uniform, the combustion pressures become more varied and accelerated wear rates of both the piston rings and cylinder liners occur.

Microbes are generally unevenly distributed throughout the two-phase oil/water system. Composed of many species, their varying life spans, ease of multiplication, preference for existing as discrete cells or aggregated together as large biomass communities means that they may adapt themselves to survive under most conditions, as shown in Figure 3.5 and Figure 3.6.

Fuel fouling is predominately an 'end-user' problem, experienced as blocked fuel filters, pumps and injectors. The trend to use finer filters on engines, increases the risk of blockage and aggravates microbial problems. This is not surprising given the fact that microorganisms can survive at the oil/water interface, in water droplets trapped within the oil phase, or as a biofilm on the internal surface of the tank, as shown in Figure 3.7 and Figure 3.8.

Stormy weather creates many of these interfaces and distributes microbes from the tank bottoms into the upper layer of fuel. However, it is often difficult to pinpoint the exact source of the problem, as each tank in the line of transfer must be considered as its own distinct environment, with the potential to support microbial growth.

Resolution of fuel contamination problems is not addressed in the present ISO8217 1987 fuel standards, since these do not specify microbial levels, stating only that the fuel's quality should be 'fit to use'. Thus, it appears that the

best remedy at present would be for ship owners/ operators to persuade suppliers to provide microbially free clean fuel. The onus is then on the ship operator to ensure that microbial problems do not establish themselves onboard. In the long term, it is clear that adequate protection should be provided by stipulating acceptable microorganism levels in future fuel standards.

However, although distillate fuels and 30 cst intermediate fuels have experienced problems, the high temperatures required for using heavier residual fuels (maintained throughout the bunker tanks, centrifuges and service tanks) dissuade virtually all microorganisms.

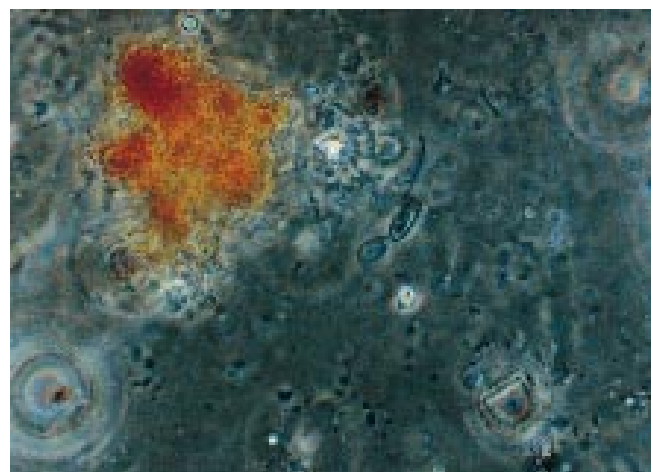

Figure 3.7
The initial stage of bacteria infestation within water droplets

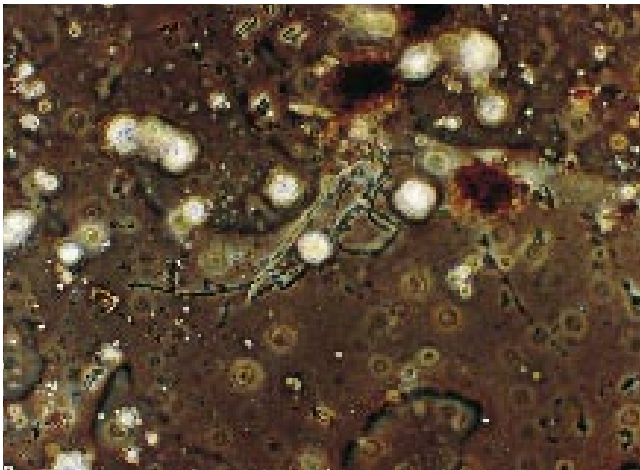

Figure 3.8
The initial stage of moulds infestation within water droplets



Figure 3.10
Lubricating oil cooler (oil side) corrosion of tubes and stays

3.2 Lubricating Oil

As for fuel, microbial growth occurs in the water associated with the lubricant, and the phenomenon is therefore characteristic of crankcase oils in wet engines, particularly those with water cooled pistons. Lubricant infection which includes hydraulic oils, can be identified by slimy film formation on the crankcase doors, there may be a rancid odour and white metal parts may be stained black. With progression of the problem, filters choke up, organic acids are formed and the oils tend to emulsify, as shown in Figure 3.9.

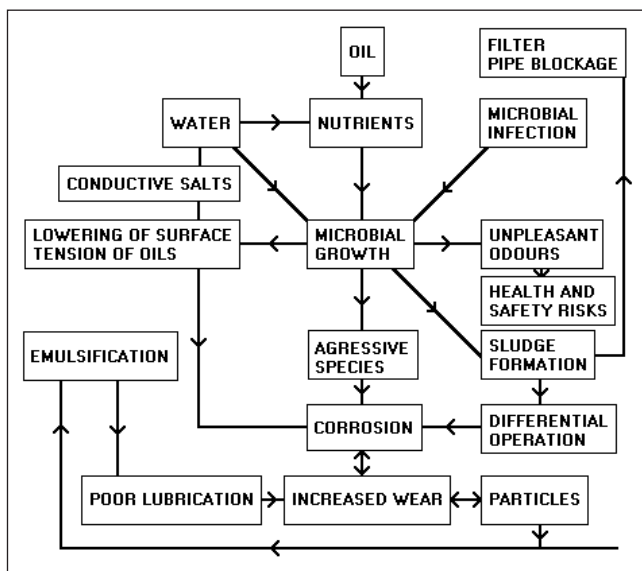

Figure 3.9
Interactive problems associated with microbial corrosion

If SRB are present, a particular problem associated with laid up ships, copious pitting of ferrous and non-ferrous metals may occur, as shown in Figure 3.10.

Since microorganisms feed upon the additives within the oil, the lubricity of the oil may be impaired, its viscosity

altered, there is a greater resultant acidity and increased potential for emulsification and corrosion. Hydrogen sulphide may also be produced as a by-product. Should these factors occur at the same time, this will result in serious corrosion problems within weeks of the initial contamination.

Sources of contamination within the lubricant are the fuel, cooling water and seawater. Cooling water has especially featured as a common contaminant of crankcase oil at engine operating temperatures, since the use of chromates as corrosion inhibitors are banned. The use of chromates also acted as an effective anti-microbial biocide.

Prevention is better than cure, and it is known that microbial growth is retarded by extreme alkaline conditions. To date, there have been no microbial problems reported with medium speed engines during operation, when using highly alkaline lubricants of BN 12 to 40. However, at such elevated temperatures, lubricating oils tend to be self-sterilising.

Unfortunately though, there still remains the possibility of infestation from contaminated bilges and tank tops which may inadvertently leak into the oil system, as shown in Figure 3.11.



Figure 3.11
Machinery corrosion and oil system contamination from tank top water ingress

3.3 Cooling Water

Microbial contamination is often identified in engine cooling water and as a result can destroy the corrosion inhibitor chemicals. The result is that the coolant may smell and discolour, develop slimes/scum and gradually become acidic. If it is of an oil emulsion type the emulsion may split into two layers.

Cooling water containing corrosion inhibitors is normally alkaline at about pH 8-9. Since the system is in circulation and aerated in use, any initial microbial contamination is normally due to aerobic bacteria. However, oxygen deficiencies occur as the flora increase and it has been found that many of these bacteria are capable of obtaining their oxygen by rapidly reducing nitrite, an anti-corrosive ingredient. The nitrite is then reduced to ammonia or nitrogen gas and the water rapidly becomes corrosive. After some time, cooling water may be sufficiently anaerobic to allow SRB to proliferate. When this occurs, with the simultaneous dispersion of the nutrient phase, rapid growth can cause spoilage within days.

If severe fouling takes place, heat transfer will be prejudiced.

If there is visual evidence of infection, it is desirable to conduct confirmatory tests. Onboard test methods can be used and/or samples sent away for professional examination and advice.

3.4 Bilge Water

To understand the microbiological and corrosion processes, no one species can be singled out from the consortia of microorganisms. Many hundreds of different species may be within each consortium, differing not only from ship to ship but within the same section of a system. Although many of these species of bacteria, yeasts and moulds can be identified and named, those parameters which optimise microbial proliferation and corrosion must relate to a consortium rather than the individual species. Micro-environments are even known to exist within consortia and differ incrementally in terms of pH, oxygen, electrode potential (Eh), chemical composition and nutrients. The microbiological process is explained as follows:

Microbiological Process: Hydrocarbons and occasionally other organic wastes contaminate the bilge water and become food for microorganisms; the oils are initially degraded by specialised microorganisms termed 'hydrocarbonclastic', as shown in Figure 3.12 and Figure 3.13.

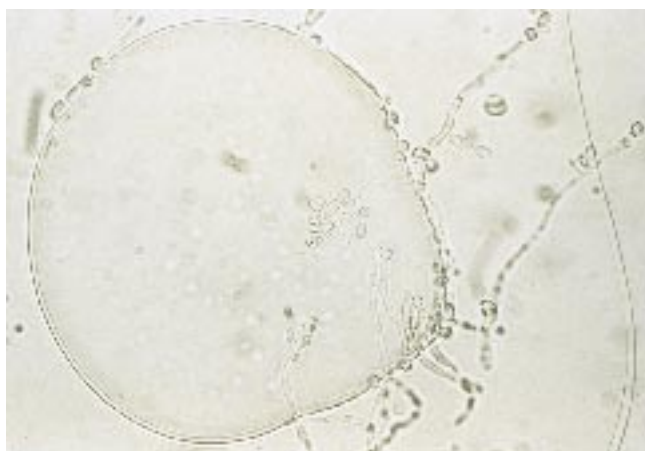

Figure 3.12
Cladosporium resinae growing around a fuel oil droplet in water

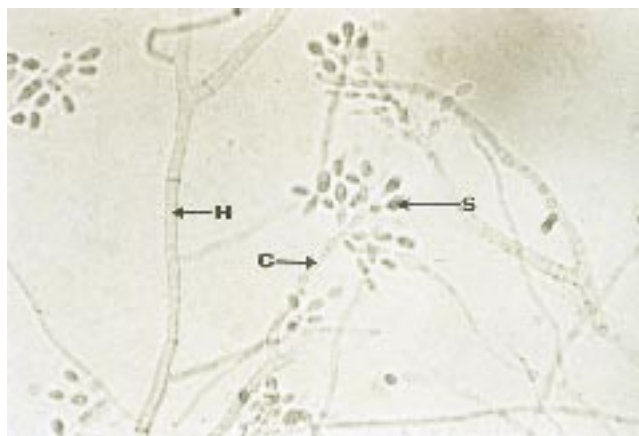

Figure 3.13
Cladosporium resinae indicating branched hyphae, conidiophae and spores

This degradation occurs only in the presence of dissolved oxygen; microbes which use oxygen in this way are called aerobes. During aerobic degradation, soluble partially oxidised compounds are formed and migrate throughout the water, in turn becoming nutrients for other microorganisms, particularly the dissimilatory SRB. SRB cannot themselves feed on hydrocarbons but only upon the organic acids, carboxylic acids and alcohols produced by hydrocarbon degraders; SRB extract and use the oxygen in sulphate to oxidise their organic food and cannot tolerate molecular or dissolved oxygen. Organisms which are intolerant of oxygen are called anaerobes. They are protected from oxygen by the activity of the hydrocarbon degrading microbes which strip out and utilise the dissolved oxygen.

The hydrocarbon degrading bacteria can also change the electrode potential (Eh) from between +200 to 300 mV positive to a value which could be greater than -100 mV negative. This is another essential parameter for SRB proliferation.

The exact boundary in the bilge water below which SRB can flourish depends upon the rate of re-oxygenation of the surface (a function of the size of the air/water interface and agitation), and the rate at which the hydrocarbon oxidising bacteria can deplete oxygen. In bilge water this boundary will probably only be realised deep in the bilges or part way through deposits of mud and slimes on the bottom plates. Any sulphate in seawater is reduced by SRB to corrosive sulphide; some of this is assimilated as a nutrient for the reproducing SRB, but most of it disperses into the micro-environment, i.e. it is dissimilated. Many other microorganisms reduce small amounts of sulphate to sulphide, but consume most of it as a nutrient; this is assimilatory sulphate reduction and is not significant in corrosion.

Other sulphur sources such as sulphurised oil and sulphonates can be degraded by microbes to yield hydrogen sulphide, evolved during protein putrefaction and typified by its offensive odour. Some of the sulphide produced will be re-oxidised to sulphur, pyrite and polysulphides in the more oxygenated regions of the bilges.

Distribution of Microorganisms: Although most samples for microbiological examination are drawn from the bilge water, very many of the microorganisms present will be entrained in slime on the plate surface (the biofilm) or dispersed in sludge deposits and corrosion product aggregates. This is particularly true of SRB; thus any positive findings of SRB in

the bilge water suggest that very large numbers of SRB are present on the steel plates. SRB may be present but relatively inactive if an appropriate consortium of other organisms is missing or physical conditions are sub-optimal.

The probable distribution pattern of organisms, nutrients etc, in the bilge water, are illustrated in Figure 3.14.

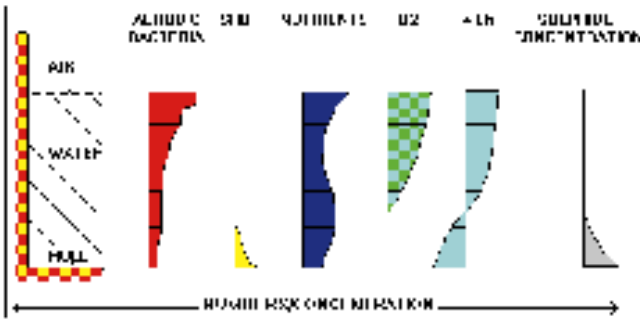

Figure 3.14
Physical, chemical and microbial changes in bilge water in relation to depth

Obviously if samples are taken and tested, different results will be obtained at different depths. It is apparent that for severe pitting corrosion to occur, the bilge water must be infested by the right mixture of microorganisms and favourable conditions must prevail; first for substantial proliferation of the hydrocarbonoclastic microbes and then for the SRB, as shown in Figure 3.15, Figure 3.16 and Figure 3.17.

These conditions relate to the increased corrosion problems which are being experienced.



Figure 3.15
SRB viable single cell about 4µm long with nutrient storage granules

Corrosion Process: Steel hull perforation by pitting corrosion is now routinely observed onboard workboats where microorganisms accelerate the usual electrochemical corrosion mechanisms. The actual microorganism corrosion process may be simplified into three distinct stages:

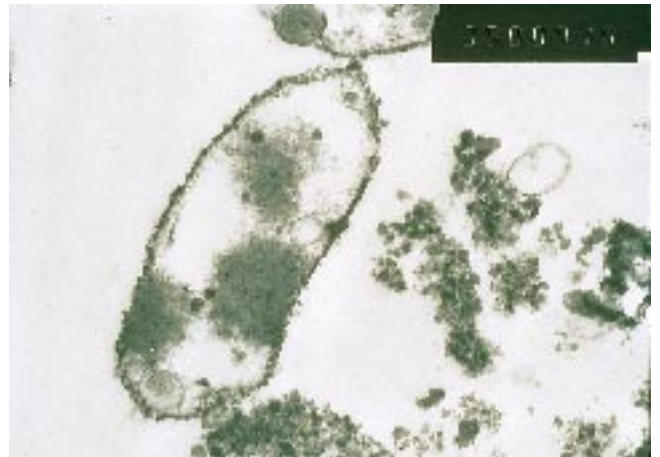

Figure 3.16
SRB viable single cell before fragmentation



Figure 3.17
SRB viable single cell after fragmentation reproducing many cells

1. Aerobic microorganisms aggregating in slimes, muds or crevices use up the available oxygen in their immediate vicinity and create an oxygen deficient area. In electrochemical terms, such an area will be anodic in relation to relatively oxygen rich zones with fewer microbes. This oxygen gradient may be regarded as an electrochemical cell, precipitating the electron flux from the cathode to the anode, allowing deep anodic corrosion pits to develop. In addition, the microbial by-product which is a very corrosive acid, also acts as an electrolyte within the cell.
2. The formation of pits is not entirely an electron process based upon aerobic bacteria. These oxygen deficient areas are colonised by the anaerobic SRB, which produces HS- and S²⁻ ions and hydrogen sulphide. These ions are highly aggressive towards steel and yellow metals, and form the characteristic craters. In carbon steel, a carbon skeleton remains visible as a graphite black colour and the bottom of each pit is usually black ferrous sulphide.
3. Simultaneously, SRB hydrogenase enzymes depolarise the surface steel. The steel becomes progressively more porous, susceptible to hydrogen ingress and hydrogen embrittlement. When ferrous sulphide forms, it is itself

cathodic and thus continues to drive the electron flow and anodic pitting, even after the SRB have died or become less active. Corrosion driven by ferrous sulphide is thought to be most pronounced during intermittent aeration or in the presence of oxygen gradients.

These three distinct corrosion mechanisms, emanating from oxygen, SRB and ferrous sulphide can occur sequentially or simultaneously, as shown in Figure 3.18.

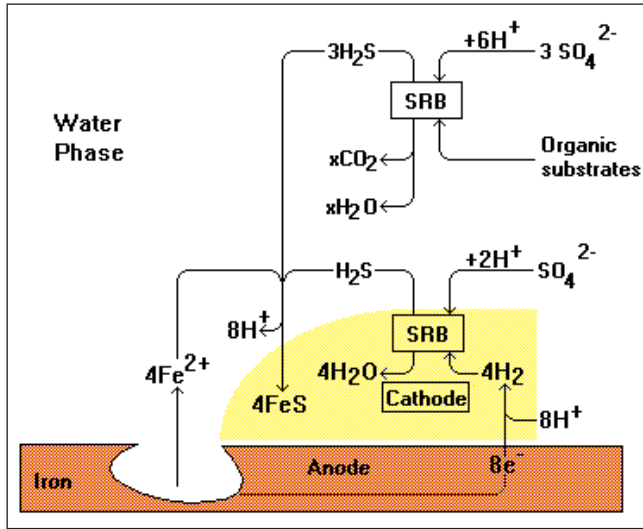

Figure 3.18
Anaerobic corrosion by sulphate reducing bacteria (SRB)

The net effect is dramatic; a corrosion rate of about 0.05 mm a year in clean seawater can be accelerated by microbial enhancement to produce craters several centimetres in diameter at the surface and deep pits. In one authenticated report, a new 10 mm hull plate perforated in less than a year, as shown in Figure 3.19.



Figure 3.19
SRB corrosion of hull plates after only 9 months

Factors Controlling Microbial Proliferation: There are several factors which contribute to microbial growth and these are as follows:

1. **Polluted waters:** The concentration of pollution within inshore waters, will ensure that any seepage into bilges will be adequately infected with all of the necessary microorganisms, to initiate corrosion.
2. **Nutrients:** Microbial proliferation is dependent upon the percentage of nutrients, such as phosphorus and nitrogen. Chemical contamination of inshore water meets this condition.
3. **Temperature:** Microorganisms prefer the temperature range 15-35°C. Conditions within the bilge are ideal, since they are typically kept at about 15°C. SRB are particularly temperature sensitive and experience a tenfold decrease in activity at 5°C. However, discharges of warm water into particular bilge sections tend to promote microorganism growth and initial attack in these areas.
4. **Stagnation:** Regulations restricting pumping, coupled with environmental regulations in the use of chemical treatment in bilges and in fuels, exacerbate existing problems. The inevitable result is to accumulate stagnant bilge water onboard which promotes SRB proliferation. Regular pumping of bilges not only prevents stagnation but also removes the main sources of microbial nutrients. This action removes the aerobic bacteria themselves and lowers the oxygenated water/air interface to a level which could be inhibitory to SRB on the bottom plates.
5. **pH:** Since hydrocarbon degrading bacteria tend to lower the pH by producing organic acids, and SRB effectively raise the pH by feeding on these acids, removing the acidic sulphide ions and monitoring the pH value provides a useful first identification guide. The pH range suitable for SRB is between pH 6-8.
6. **Onboard contamination:** Stimulatory nutrients can be present in the bilge itself, originating from urine, food wastes and sewage. Any traces of detergent will emulsify the oil and render it more available to the hydrocarbon degrading microorganisms, by creating greater interfacial oil/water surface area.

Correlation between Microorganism Species and SRB Corrosion: Although the microbiological and corrosion processes are known, as are the factors controlling microbial proliferation, no precise correlation from analytical data can predict when corrosion pitting is imminent. Problems in correlating microbial test results of bilge water samples are affected by the variety of microbial environments within the bilges, pumping restrictions, pumping intervals, position of sample and onboard practices. The results from laboratory tests have indicated certain correlations between microbial species and SRB corrosion, which identifies the initial requirements for microbial corrosion.

During the tests, the Total Viable Count (TVC) per ml of aerobic bacteria was determined and the yeasts and moulds contamination, as well as the SRB presence which were assessed semi-quantitatively. The pH was measured for most samples. The results from these tests are indicated.

1. These measurements indicated that different sections of the bilge may differ in their stimulation of SRB.
2. As a whole the results suggest that SRB tend to proliferate when aerobic bacterial numbers are high, although there is no absolute correlation.
3. There is no correlation of SRB with the numbers of yeasts and/or moulds or with pH.
4. There is however, correlation between yeasts/moulds

proliferation and pH, proliferation being favoured at \leq pH 6.9 and suppressed at \geq pH 7.0. This is more marked when SRB are also present.

5. The presence of SRB is strongly correlated with high (TVC) for bacteria (but not with the presence of yeasts/moulds) and, more importantly, with greatly accelerated pitting corrosion. Corrosion seems to be most severe at slightly alkaline pH.

Rectifying bilge water contamination is not easily addressed but corrosion problems can be prevented by implementing correct procedures.

3.5 Ballast Water

The corrosion of ballast tanks follows the same electrochemical process resulting in SRB crevice corrosion damage, but is dependent upon nutrient concentrations such as nitrogen and phosphorus within the water and accumulation of muds, slimes and sludges on the tank bottoms.

An additional risk in ballast water is that it can also harbour microorganisms, of the type which not only endangers the ship's condition but also human health.

In November 1991, a strain of cholera was discovered in the ballast water of three ships at ports on the east coast of the United States after the ships had called at ports in South America. In June 1992, a further two ships intercepted at eastern United States ports were found to have traces of cholera in their ballast water. In Australia, scientists examining the ballast water of a Norwegian ship which arrived at a Queensland port from Singapore, discovered a strain of organism which could cause botulism in animals and humans.

Ballast water can also transport a host of other unwanted organisms. Non-indigenous species have been introduced in other parts of the world through off loaded ballast water. These species have acted both as predators and competitors to indigenous microorganisms. Invading plankton species have caused toxic algal blooms and other invading species have acted as parasites, pathogens and disease carrying agents, so wreaking havoc in their domiciliary oceans, rivers and lakes.

In response to these dangers the following steps can be taken:

1. Avoid taking on ballast in shallow waters;
2. Keep an accurate record of where ballast is loaded;
3. Endeavour to exchange ballast water at sea where organisms are rarer;
4. Only discharge ballast into approved areas of the port.

Reballasting at sea before ships enter local waters has been advocated in certain quarters as a permanent solution, but is not a satisfactory answer. Random tests have shown that of ships which claimed to have exchanged their ballast in mid-ocean, almost half still contained significant amounts of sediment with *Dinoflagellate cysts*. In one case, these organisms survived two changes of ballast water.

Combating microbial contamination of ballast water still requires more field testing for its resolution. These field tests could include removal and/or extermination of organisms in ballast water via microfiltration, ultraviolet, ultrasonic and thermal treatment, altering the salinity, and sediment management.

The most obvious immediate solutions for the effects of microbial contamination are to segregate ballast tanks and to use appropriate epoxy resin coatings. Another option is the chemical treatment of ballast water, but this may cause as much environmental damage as some of the microorganisms

themselves, if allowed to be discharged within restricted areas. An alternative and well established solution would be to heat the ballast water to kill the microorganisms; in practice this is far too expensive and time consuming to offer a practical remedy.

3.6 Distillate Cargoes

Very many types of microbes can utilise hydrocarbons as a nutrient and energy source. However, in time, consortia develop which are adapted for optimum growth in a particular fuel and given environment. Development of problems is related to the mixture of organisms, types and numbers, but there are no hard and fast rules. For example, although bacteria might be found in clean seawater they will probably not be a potential fuel hazard. Microbes from a previous gas oil problem would be an immediate hazard to fresh gas oil.

When a cargo of fuel is rejected because of microbial spoilage, it becomes important to isolate the dominant microbes in the consortium and identify them accurately. All sources which could have contributed to the spoilage consortium should be sampled and tested; usually relevant samples already exist, from load port storage tanks, individual ship's tanks at load and discharge ports and receiving tanks (before and after filling). Bacteria and yeasts can be accurately fingerprinted by subjecting them to a battery of tests. A useful set of tests (API 20 NE) can be obtained for fingerprinting bacteria by assigning a numerical profile to them. The tests are carried out in triplicate and in each set of three, negative results are rated 0 and positive results score either 1, 2, or 4. The first triplicate set consists of:

Reduction of nitrate	0 or 1
Tryptophan degraded in indole	0 or 2
Glucose degraded to acids	0 or 4
Total score	?

Thus, three positive results would score 7, the first two results being positive would score 3 and so on. Using seven sets of three tests a seven figure digit is built up (e.g. 1140575 = *Pseudomonas aeruginosa*). The name of the bacterium is not usually important, but the number is an accurate label which can discriminate between over 2 million different organisms. All possible sources of contamination can be tested this way and any microorganisms detected can be fingerprinted as numerical profiles. Culpability can then be deduced. The same strategy can be used if a ship is delayed or damaged by infected fuel and the source is unknown.

Even though this technique enables the accurate identification and tracing of contaminating microorganisms, the rate and severity of spoilage cannot yet be attributed to any particular strains of microbe. It is also not possible to fix maximum limit values on numbers of microbes which are acceptable in the fuel or water phases.

4. PREVENTION AND ELIMINATION OF MICROBIAL CONTAMINATION

4.1 Prevention

Traditional measures for the prevention of microbial infection fall into three broad categories: good housekeeping, physical cleaning and biocide treatment. In addition, there are a number of alternative strategies that have been considered but not commercially implemented.

A number of factors control the rate at which microbiological problems will develop and indeed, whether problems will develop at all:

1. Without infestation of a system microbial problems can not arise. Unfortunately, this is never the case and low numbers of viable microorganisms will always find their way into a system.
2. If they reproduce slowly, the progeny will be removed whenever water is removed and large numbers of microbes will not accumulate.

However, a large influx of microbes resulting in a heavily contaminated system will defeat this simple self-regulating mechanism; there are more microbes to reproduce and the potential for future problems will have been established.

4.1.1 Physical Prevention

Water is critical for microbial growth and all fuel and lubricant systems contain water droplets. Its presence always presages the potential for contamination. The amount of water required to support growth is not great, nor does it need to be present in the tank and systems all of the time.

Thus, the first line of defence against contamination is to keep the system as dry and clean as possible by limiting water ingress and preventing the spread of microbes within the system. As a general rule, the more water that is present, the more microbial growth it sustains, yet even more critical is minimizing the overall oil/water interface to limit any transfer of microbial contamination. Obvious leakage of water into the fuel and lubricant should be corrected immediately, but other sources of moisture from humidity and condensation entry during transportation to the ship's tanks might be impossible to eliminate. When water contamination is detected, centrifuging and drawing off from tank bottoms is recommended. Thus periodic inspection and cleaning of tanks and systems is essential. Filters should be cleaned or replaced frequently depending upon their type.

Good housekeeping is often almost impossible within the constraints of poor system design. Dead legs of pipework should be avoided and multipurpose pipes should not be used in case one of the pipes introduces microbial contamination into the system. Other aspects of good housekeeping are preventing cross-contamination of infected and clean tank systems, and guarding against accidental contamination. As the optimum temperature for microbial growth is in the range of 15-35°C, storage at this temperature should be avoided. Conversely, elevated temperatures are useful in that they help sterilize tanks and pipework. Scale and rust particles stimulate the growth of microbes and should therefore be removed. Surfactants also stimulate growth and enable microbes to pass more freely into the fuel and lubricant phase.

Whilst frequent water drainage is the best preventative measure, modern microbial strains wrapped in their protective polymer coating frequently remain in the tanks after the drains have been operated. The drain valve should be cracked open several times during a draining procedure to give micro-

bial slimes and water time to move to the exit point. Biofilm on surfaces will remain in place adhering to surfaces. Furthermore, large tanks can accumulate substantial quantities of undrainable water. Even the most meticulous maintenance, however, cannot completely eliminate the potential for microbial problems.

Fuel Oil: Fuel suppliers should be carefully selected for quality and consistency of their products. Confirmation of microbial contamination in fuel using shipboard tests takes several days, which is more than enough time for a contaminated bunker supply to infect the entire system. If water in the fuel is present, a sample should be taken for testing using shipboard tests. This will give a result within an hour and an initial indication of possible problems.

Certain procedures are recommended to avoid microbiological problems:

1. Design systems to allow maximum water drainage;
2. Ensure adequate draining schedules;
3. Alternate fuel tank usage to prevent stagnation, especially double bottom tanks;
4. Use the cleanest water available for tank washing;
5. Regularly clean and disinfect purifiers, filters and coalescers;
6. Do not mix clean and suspect fuels;
7. Use connections which will not allow water to mix with the fuel;
8. Regularly check tank coatings and evidence of contamination;
9. Use test kits to check fuel samples;
10. Audit the fuel suppliers.

Lubricating Oil: Since the majority of operational microbial problems in lubricating oils arise due to infection from cooling water, seawater from cooler leaks and overflows of contaminated bilges, plant treatment effectiveness and efficiency is an important remedial measure.

Certain procedures are recommended to avoid microbiological problems:

1. Ensure water content of crankcase oil does not rise above 0.5% wt. content;
2. Check purifier suction is as near to the bottom of the sump as possible;
3. Maintain minimum oil temperature after purifier heater at 70°C or higher for at least 20 seconds, and/or 80°C for 10 seconds;
4. Circulate the volume of oil in the sump via the purifier at least once every eight to ten hours;
5. Regularly check coolant corrosion inhibitor concentrations are at the manufacturers' recommended values;
6. Monitor the microbial population of the cooling water and prevent water leaks into the oil system;
7. Test for microbial contamination of the oil system and monitor if the oil after the purifier is sterile;
8. Prevent ingress of contaminated bilge water;
9. Inspect storage tanks and regularly check for water.

Cooling Water: In many cases, it is likely that the water supplied to the cooling water system is not only the main source of microbial contamination, but also the source of infecting microorganisms to other systems.

Certain procedures are recommended to avoid microbiological problems:

1. Ensure the correct anti-corrosion chemical value is maintained;

2. Monitor the alkaline level and ensure that it does not fall below pH 8-9;
3. Check supply water for dissolved salts, as these will contribute nutrients for microbes;
4. Insert a polished mild steel bar in the bottom of the tank and regularly examine it for signs of SRB;
5. Test for microbial contamination in the supply water and cooling water system.

Bilges: The restrictions which have limited bilge pumping and turnover rates are probably the prime reason for the current increase in corrosion. Also, the design of deep narrow bilges is more susceptible to microbial corrosion as it is not so easily re-aerated from the water/air interface as flat bilges.

It is axiomatic that once microbially enhanced corrosion has started, it cannot be stopped simply by adding anti-microbial chemical biocides. These cannot penetrate biofilm, sludge or mud at normal, safe, in-use concentration; microbes entrained therein survive. It has also been determined that once ferrous sulphide has formed it will continue to act as a cathode even though the SRB which generated it have been killed. Cleaning is a pre-requisite for successful microbiological decontamination and it also removes aggressive corrosion products.

Certain procedures are recommended to avoid microbiological problems:

1. Regularly pump bilges to prevent the water becoming stagnant. This action also removes the main source of microbial food i.e. hydrocarbons and their partly degraded by-products and aerobic microbes themselves. This will also lower the oxygenated water/air interface to a level which could be inhibitory to SRB on the bottom plates.
2. Apply a barrier coating to the inside of the bilges. The practical difficulties in preparing the surface and producing a sound, adherent coating are enormous and any defects would be the foci of oxygen gradient pitting, accelerated by aerobic microorganisms present, and not necessarily dependent upon the intervention of SRB.
3. Suppress electron flux by cathodic protection (CP). Corrosion rates could be reduced, but the microbial population would continue to flourish and would become corrosive in any poorly protected locations. It might only be possible to use CP in combination with a coating. More CP will be needed if biofilms are present.

Ballast: Problems relating to ballast tanks are usually attributable to SRB corrosion and are associated with several species, the most prominent being *Desulfovibrio* and *Desulfotomaculum*, whose spores can be resistant to both oxygen and chemicals. Onboard testing must target aerobic degradative microorganisms and anaerobic SRB.

Certain procedures are recommended to avoid microbiological problems:

1. Regularly inspect tank coatings to prevent pitting corrosion;
2. Check cleanliness of surfaces and prevent slimes and sludges from accumulating;
3. If tanks are dry, monitor any water ingress and drain off free water;
4. Ensure no polluted harbour water is taken onboard for ballast;
5. Test and monitor for any microbial contamination.

4.1.2 Chemical Prevention

Good housekeeping strategies against imported contamination and onboard grown microorganisms are preventive measures which can be taken at sea. However, once a ship's system has become heavily contaminated, the infecting microbes will pose an ongoing potential hazard and final resolution of the problem will involve the use of anti-microbial chemical biocides.

Fuel and lubricant preservatives protect against possible minor infections over a prolonged period, being slow acting but persistent.

4.1.2.1 Fuel Preservatives

Anti-microbial chemicals are generally referred to as 'biocides'. Those which are designed to kill sporadic minor contaminations over a long period are also designated 'preservatives'. They will not necessarily cope with major contamination and have the best chance of success if coupled with good housekeeping procedures.

Any chemical agent used as a preservative and targeted at preventing the proliferation of organisms must be sufficiently water soluble to migrate into and disperse within the water phase. In some cases, the addition can only be made via fuel and hence fuel solubility or dispersancy is necessary. If long term preservation of a fuel is required sufficient agent must remain dissolved in the fuel to protect it wherever it is transferred. If long term protection of a tank is required, sufficient agent must remain in the water bottom despite many re-fuellings. If no fuel movements are envisaged it may suffice to add a water-soluble agent directly to the tank bottom. However, it is usually argued that some fuel solubility allows inaccessible discrete water phases to be targeted.

Thus, the solubility ratio in fuel and water is a critical parameter and an agent must be selected which has the correct solubility characteristics for the planned use.

An anti-microbial agent dissolved in fuel destined for normal engine use should:

1. Be combustible, leaving no ash or corrosive residues;
2. Not to be surface active;
3. Be compatible with the fuel additives and fuel system components, e.g. sealants;
4. Not affect the fuel flash point;
5. Not promote oxidation, corrosion or gum formation;
6. Have a safe in use concentration; 'The Control of Substances Hazardous to Health' (COSHH) regulations will apply;
7. Be active against viable microorganisms in the fuel and water phase;
8. Have no adverse environmental impact when discharged as waste from the tank drains.

The latter characteristic is of prime importance. Chemical preservatives are toxic to man and the environment; some are deactivated by modest dilution – others must be deactivated by the addition of a neutralising chemical, such as bisulphites to neutralise isothiazolinone preservatives. The neutraliser must itself be environmentally acceptable – in the example quoted, bisulphites exhibit a chemical oxygen demand which may be unacceptable.

To optimise preservation, the required water phase concentration should be known and preferably monitored to ensure that the target concentration is maintained.

Isothiazolinone preservatives are marketed for fuel use under a variety of trade names and in various concentrations. Possibly the best formulation is one which incorporates glycol;

	<i>FUEL BIOCIDES</i>	<i>HEAT FUEL</i>	<i>FILTER 0.5 μM</i>	<i>FILTER 5 μM</i>	<i>WATER BOTTOM BIOCIDES</i>
MICROBES IN FUEL KILLED/REMOVED	YES	YES	YES	SOME	NONE
DEBRIS REMOVED	INITIALLY WORSE	AGGREGATES ONLY	YES	SOME	SOME
BIOSURFACTANTS REMOVED	OFTEN WORSE	MOST	SOME	SOME	SOME
H ₂ S REMOVED	NO	NO	NO	NO	NO
TANK DECONTAMINATED	PARTIAL TO MOST	NO	NO	NO	PARTIAL

Figure 4.1
Efficacy of decontamination strategies

this imparts desirable solubility characteristics. A concentration of 100ppm (1.5 ppm of active ingredients) in the fuel is proposed and is said to equilibrate with 81-125 ppm in the water phase. The water phase concentration is easily determined and it should preferably always be above 15 ppm. Glycols and organo-borates are used as fuel preservatives in the aviation industry, but have limited use in marine fuel.

Use of a fuel preservative requires ongoing vigilance which may only be possible if a ship has one source of fuel. Intermittent use of preserved fuel could encourage the emergence of resistant microbes, exacerbating existing problems.

4.1.2.2 Lubricant Preservatives

Onboard addition of biocides as a soluble preservative into the lubricant system is usually effective as an avoidance strategy, but it will have a short useful life in hot oil, tending to migrate from the oil phase to the water phase. These difficulties and differences in plant treatment systems, types of lubricating oils, operating temperatures and complex additive packages in the lubricant, control the use of an oil soluble preservative. This has been identified by some lubricating oil suppliers and they now include soluble chemical biocides within some of their product ranges.

4.1.2.3 Water Preservatives

Fuel insoluble anti-microbial chemicals can be introduced to the tank top in water soluble sachets or injected into the tank bottom. These chemicals should be amenable to simple concentration monitoring and detoxification before drain water disposal. There should be no biocide carry over from adjacent tanks or tank to engine. Addition of a water preservative to the engine cooling system must adhere to safety standards in the use of that chemical, if the cooling water is used for producing potable water for onboard consumption.

4.2 Elimination

4.2.1 Physical Decontamination

Microorganisms do not die naturally – they must be killed. Once microbial infection is established onboard it may be combatted by physical treatment methods e.g. heat and/or by the use of biocides. Dead organisms will still plug filters and

supplementary filtration may be advisable to remove them, as shown in Figure 4.1.

Settling: Since microbes are denser (specific gravity 1.05 gcm³) than distillate fuels and lubricants, they will gravitate towards the bottom over a period of time; the larger the microbial aggregation, the quicker the settlement. Microbial polymers and debris also settle out, although there have been cases where this has not happened, for example when there is entrained gas. Clean oil can thus be drawn from the top of tanks after settling, as shown in Figure 4.2.

Centrifuges and Cyclones: These remove considerable microbial fouling. The centrifugal forces generated in a purifier are sufficient to spin out heavier microorganisms. The rate at which they separate out is affected by their degree of aggregation, the viscosity of the oil and the retention time. There is obviously a delicate balance involved in optimising conditions, as an increase in retention time will increase microbial removal, but it will also reduce the volume of oil treated, as shown in Figure 4.3.

Filtration: As most individual microbes have a cell size of only a few μm and some are even less than 1 μm, effective removal by filtration can be accomplished successfully using a series of appropriate filters, even if the filter pore sizes are far greater than the size of the microbes. Flow rates of 100-250 m³ per hour using 5 μm filtration, should be adequate for a clean-up in most cases, as shown in Figure 4.4.

Heat: Heat processes have two variables, temperature and time of application. As an indication of actual practice, milk can be pasteurised at 71.7°C for 15 seconds or 62.8°C for 30 minutes. This does not sterilise the milk but considerably reduces the microbial population. Microbes which flourish at high temperature are more difficult to kill by heat. Hence, microbes in engine lubricants and coolants can be expected to be less sensitive to heat treatment than organisms in cool systems. Microbes are also known to have different sensitivities when suspended in the water phase and oil phase. We can expect purifier heaters and renovating tanks to reduce microbial populations in engine lubricating oil if batch heat sterilisation is carried out in the renovating tank. It is important to clean and sterilise the sump and system before returning the sterilised oil. The purifier heater plays a signif-



Figure 4.2
Contaminated fuel oil after being allowed to settle

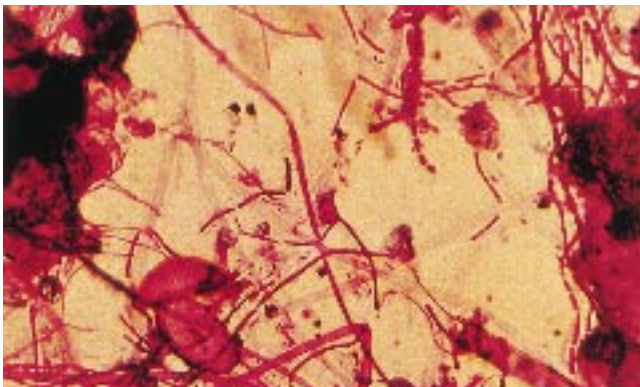

Figure 4.3
Slime formation collected from the purifier bowl indicating mixed microbes

icant role in continuously killing microbes passing through it and the overall effectiveness can be confirmed by onboard tests, as shown in Figure 4.5.

In any system there are likely to be permanent temperature gradients and different populations of microbes may be more active in different parts of the system, according to their temperature optima. Although heat in excess of 70°C and for

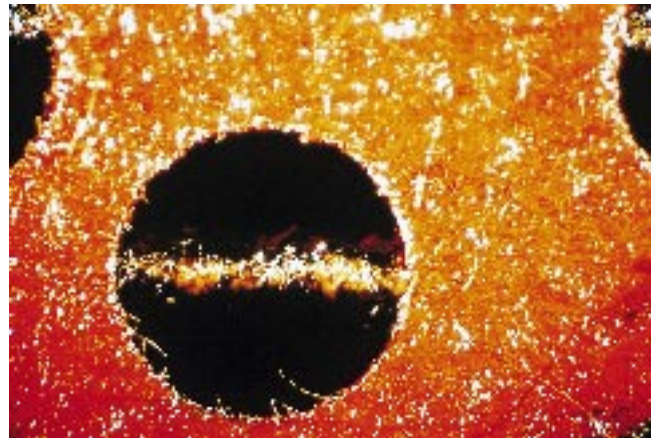

Figure 4.4
Microbes being trapped by small filter pore sizes

20 seconds will kill spoilage microbes, it is difficult to achieve this temperature on tank surfaces, either by very hot washes or steam lances. The efficacy is usually disappointing as heat losses across metal surfaces are so rapid that biofilms remain intact.

4.2.2 Chemical Decontamination

Killing microbes by chemical means is not difficult, but it has been proven that it is hazardous to attempt to do so unless it is known that the biocide is chemically compatible with the fuel and lubricating oil in use, does not affect its physical properties (particularly demulsification), and has no other unacceptable adverse effects.

Oil biocides should not be used without prior discussion with the fuel and lubricating oil supplier or an experienced consultant. These biocides have a finite life, being expendable either due to absorption by the microbes they kill, or leaching from the oil into the water phase. The wetter the conditions, the more rapidly they will be depleted.

Whilst the use of the wrong biocide can have disastrous effects, even the correct biocide must be used carefully and at the right concentration. Underdosing will not cure the problem and overdosing can pose a health hazard to the crew due to toxic vapours.

Heater temperature & holding (time secs)	Bacteria/ml	Water content (%)	Particulate (mg/ml)
60°C			
0s (before heater)	7.3×10^6	1.0	1.52
12s (after heater)	4.1×10^3	–	–
30s (after purifier)	7.0×10^2	0.45	1.57
70°C			
0s (before heater)	7.3×10^5	1.0	2.52
12s (after heater)	0	–	–
30s (after purifier)	0	0.35	1.52
80°C			
0s (before heater)	7.3×10^5	1.0	2.52
12s (after heater)	0	–	–
30s (after purifier)	0	0.30	1.28

Figure 4.5
Heat treatment of viable microbes

There are obvious requirements for a biocide to be effective. Whilst killing the organisms and suppressing re-infection, the treatment must not affect the quality of the fuel, degrade lubricating oils or be corrosive to metals in the system. Suitable biocides in almost all cases will be soluble in water.

The most effective biocide is usually a blend of toxicants which destroys a wide range of microbiological species, acting efficiently on the tank bottom area as well as at the water interface. It should also contain dispersing or sludge solubilising agents which will gradually remove deposit accumulations and enhance the fuel flux characteristics throughout the system.

Fuel Oil-Decontamination of Lightly Contaminated Systems: Many fuel systems are operated successfully using intermittent chemical decontamination with fuel biocides, as part of routine microbiological monitoring against predetermined limit values. These limits prevent serious fouling or malfunction and enable the fuel to still be used after decontamination. It can be argued that this strategy is easier and cheaper to operate than preservation. There are two basic elements in decontamination, i.e. destroying microbes and cleaning surfaces.

Effective fuel biocides utilise oxazolidines or morpholines as active ingredients. Concentrations of 500-1000 ppm are usually appropriate with a contact time of 6-12 hours. Slightly lower concentrations are said to be suitable for longer term preservation. After the addition of the biocide to the fuel this is circulated through all parts of the system.

In most cases, effective killing is accompanied by detachment of biofilms, such that dead and moribund microbes foul the fuel and must be removed if the fuel is to be used. Centrifuges and filters are usually employed for this and the final filtration stage using a filter rated at 20-50 μm , would substantially remove microbial aggregates.

Fuel Oil-Decontamination of Heavily Contaminated Systems: Chemical decontamination of heavily fouled fuel systems is really a modification of the preceding section. Here however, the biocide will be needed in the fuel at a higher concentration and the fuel phase will probably be unusable. In the worst case pumping out the treated fuel will not be sufficient; the empty tanks will require further cleaning and de-sludging. The fouled fuel may only be suitable for down-grading or re-refining.

The use of biocides is an acceptable method of treatment. As soon as microbiological fouling of fuel oil is observed or suspected, shock dosing with a biocide is essential. This should be followed by extensive mechanical cleaning and the use of disinfectants if the contamination is heavy. After chemical treatment, filters will require frequent cleaning until the established network of microbial biomass and remains has been removed from the system.

It should be remembered that the action of the biocide in killing the microorganisms will allow them to settle at the bottom of the tank and gradually build up as sediment. During heavy weather the sediment can often be distributed resulting in blocked fuel lines and filters, thus possibly endangering the safe operation of the ship.

Lubricating Oil-Decontamination of Lightly Contaminated Systems: Within lubricants, a more complete and elaborate array of additives is being employed, with the consequence that more of the required trace elements may be freely available for microorganism proliferation. This may be counteracted, and already is in some cases, by specific biocides or metals which exert an inhibitory effect upon growth.

Biocides cannot make an oil 'better', they merely prevent it from getting worse.

Rectification of lubricating oil is possible if the lubricant is passed through centrifuges and simultaneously heated above 70°C, so killing and removing microorganisms at a faster rate than they can incubate and grow. If this fails to eliminate and/or contain the contamination, the centrifugal heating period should then be supplemented by treating all the lubricant with biocide and afterwards manually cleaning all the machinery surfaces. After treatment, the oil should be confirmed as suitable for use prior to running the engine. Continued monitoring should be implemented to identify any re-infection.

Lubricating Oil-Decontamination of Heavily Contaminated Systems: If re-infection returns, the previously treated oil should be flushed out of the system, manually and chemically cleaned and finally replaced with an entirely new charge. Professional advice should be sought as to the cause of this re-infection, as shown in Figure 4.6.



Figure 4.6
Gearbox system which continued to be re-infected until manually cleaned

Cooling Water: Once microbial contamination is established, the infection will not be eliminated unless a chemical biocide is used. The choice of biocide is an important consideration, as many biocides are deactivated at high temperatures, particularly when in the presence of certain anti-corrosion additives. If the cooling water is used for the distillation of onboard water, it is not permissible to add toxic substances to the system. Thus there should not be an on-going preventative biocide dosing regime. Biocides can however be used to decontaminate a cooling system on a 'shock dose, circulate and discharge to waste' basis. Any biocide used must be water soluble and have a fast action of 12 to 24 hours. However, if the cooling water is not used for distillation, biocides can be routinely dosed to avoid microbial spoilage.

Bilge: Treatment with biocides is typically very cost-effective, especially when compared with the potential costs of microbial damage.

The problem is not always immediately addressed by all types of biocides. As previously discussed, the SRB strain *Desulfotomaculum* has the ability to produce spores resistant to air and a variety of biocides. In general, the effectiveness of biocides is only assured if they are carefully selected to combat particular infecting strains, being monitored and replenished as necessary.

Prompted by regular testing, and on the assumption that a high risk situation exists, a variety of strategies can be considered and implemented.

1. Commercial detergent hypochlorite bleaches are usually successful. Their concentration is readily monitored in-use and they can be deactivated after a suitable contact time by the addition of sodium thiosulphate. At alkaline pH, hypochlorite destroys the structure of biofilm, but its anti-microbial power is poor. An acid addition later in the decontamination procedure will enhance the microbial cull in the now ruptured biofilm. Alternatively, hypobromite can be used as it is both disruptive and lethal at high pH.
2. Use a broad spectrum persistent biocide continuously to kill or suppress bacteria (including SRB) yeasts and moulds. The correct biocide choice is important. Broad spectrum biocides are likely to be toxic both to man and the environment. Their effective life is finite (it may be days or weeks) and some biocide concentration monitoring will be needed to plan a biocide top-up regime. Before disposal in discharged bilge, biocides may require deactivation. However, some biocides have a minor environmental impact and dilution before discharge (e.g. in 'grey' waste water) or simply a slow discharge into an infinite volume of seawater may be acceptable. There is a precedent for this as biocides are widely used to prevent biological fouling in seawater cooling systems. Measured biocidal additions will be needed for all sections of the bilges at risk. This may be physically impractical although there are some tablet or 'stick' biocides which ease this problem. Whatever type is used, the biocide must disperse throughout the bilge sections to be effective. A biocide regime will only be effective following cleaning/sterilisation and ensuring an adequate dose is continually added to maintain levels.
3. Use a narrow spectrum biocide active only against SRB. Toxicity to man and the environment is low; persistence is good.
4. Pump bilges frequently into a bilge slop tank. A biocide is not added to individual bilge sections, but only to the slop tank. There is some merit in this approach as it mimics the situation before restrictions on bilge pumping were introduced. However, some ships have design features which ensure that significant volumes of stagnant bilge are never removed and have ultimately suffered dramatic hull perforation. For these ships anti-microbial chemicals are required.
5. Add alkaline corrosion inhibitors to all sections of bilge to maintain a value above pH 8.5 which is easily monitored onboard. This will suppress SRB but not other bacteria.
6. Oxygenate the bilges regularly, for example with hydrogen peroxide.
7. Add nitrate to all sections of the bilge to reduce the amount of corrosive sulphides produced. Nitrate is a preferred food to sulphate for SRB and its reduction yields mostly nitrogen gas and ammonia but not corrosive sulphates. This strategy has not yet been tried on ships as there is a downside which could be disastrous; once the nitrate has been used up, the SRB may renew their corrosive attack even more vigorously. Careful monitoring and control would be essential.

Ballast: Identification of SRB infection is evidenced by severe crevice pitting and accelerated corrosion between inspections. The presence of black slimes and sludges (or are black when scraped) and the potent odour of hydrogen sulphide, would confirm that a hazardous microbial consortium is present.

Effective treatment would require that the bottom plates to be cleaned and any rust manually removed to expose the bare steel. A biocide should always be applied to kill any viable microbial presence within these crevices. It is important that upon completion of this pre-treatment a suitable paint coating is applied.

Distillate-Decontamination of Heavily Contaminated Cargoes: The procedure for adding a chemical biocide will not be cost effective if very large volumes of fuel are involved. The more appropriate strategy here would instead be, to pump out the fuel and decontaminate the empty system using water and detergent sterilisers. Choice of such agents is theoretically wide, but in practice, cargo contamination can be experienced where the local supermarket may be the only quick source of supply. If the problem arises onboard, the cost of delaying the ship will be high – whatever is available locally must be utilised as an interim solution. Professional onboard supervision may be the best ongoing guarantee of success.

There is no magic chemical formula which quickly and effectively works in all circumstances. As a general and obvious rule of thumb, heavy infestations require more biocide. Beyond this, the decontaminating aqueous solution should have the following characteristics:

1. A broad spectrum of anti-microbial activity;
2. Fast acting; a 99.9% kill rate in the time allotted, less than 12 hours is a reasonable target;
3. Penetrate and disperse the biofilm;
4. Emulsify and disperse residual fuel;
5. Be unaffected by seawater if this is the diluent;
6. Be amenable to rapid onsite concentration monitoring;
7. Chemically formulated to enable neutralisation or, if not, be suitable for disposal without treatment;
8. Ensure it is safe in use;
9. Produce controllable foam;
10. Market available worldwide.

This is a daunting list of properties and few chemical suppliers have seriously addressed them all.

Only three relevant groups of biocides can currently be simply monitored onboard, namely halogen-based chlorine, phenols and formaldehyde releasers. All are absorbed and depleted in use and must be topped-up, possibly on an hourly basis, to sustain their activity. For example, hypochlorite is a convenient source of chlorine; when formulated with wetting agents and dispersants, it is readily available under various trade names and concentrations in the domestic and industrial markets. It meets most of the requirements listed above; monitoring free chlorine concentration needs care but the procedure is quick and the result can be immediately acted upon by topping up with more formulated hypochlorite. Whilst more than 50 ppm available chlorine can be aggressive to metals, less than 20 ppm is undesirable if a rapid penetration and kill is sought. It is not difficult to adjust between these concentrations, but substantial depletion of available chlorine must be anticipated. Chlorination is not effective at alkaline pH and acidification with hydrochloric acid may be needed. Alternatively, sodium bromide may be added as this increases efficacy under alkaline conditions. At the end of the procedure, residual chlorine can be deactivated with a quantity of sodium thiosulphate pentahydrate which is readily available. Excess thiosulphate is undesirable as it exhibits a high chemical oxygen demand. Manual cleaning and de-sludging could be necessary before or after biocide treatment. A final wash with clean water should then return the tank to service.

4.3 Alternative Strategies

There are a number of alternative strategies to the traditional biocidal treatment of contaminated systems. As with the methods for detection of microorganisms, many techniques have been adapted from other industries and are still at the research and development stage. They include:

- U.V. radiation;
- Gamma and x-radiation;
- Ultrasound;
- Microwave energy;
- Continuous pasteurisation;
- Heat control.

These processes were reviewed at a meeting of the Institute of Petroleum in 1985. Each treatment method has its advantages but none has been adopted commercially. The disadvantages of using radiation mean that large and technically complex plants are required for this type of treatment. Similarly with heat processes, the dissipation of heat energy after treatment is a major problem which requires capital investment for cooling facilities.

5. HEALTH CONSIDERATIONS

5.1 Microbial Hazards

Microorganisms are included as 'substances hazardous to health' in the UK 'Control of Substances Hazardous to Health Regulations' (COSHH), 1988. It would be prudent to comply with these regulations.

Conventional pathogenic (disease producing) microbes are not normally found in fuel and lubricants but two opportunistic pathogens, the bacteria *Pseudomonas aeruginosa* and mould *Aspergillus fumigatus* are sometimes detected. These are common spoilage microorganisms with a potential for causing clinical infections in susceptible individuals. The most likely route into the body is via inhalation as an aerosol spray/mist. In addition, most spoilage bacteria contain endotoxins, which when inhaled as an aerosol can give rise to flu-like symptoms.

Of far more concern, is hydrogen sulphide, emanating from SRB in tank and bilge water bottoms after extended storage and stagnation. This is a lethal gas which is more toxic than hydrogen cyanide. Typical hazardous concentrations in air are indicated in the Figure 5.1.

3-50 ppm	Offensive odour.
50-300 ppm	Injuries to eyes, respiratory tract, dizziness.
100 ppm	Loss of sense of smell.
300 ppm	Life threatening.
700 ppm	Rapidly lethal.

Figure 5.1
Hazardous hydrogen sulphide concentrations in air

The danger associated with hydrogen sulphide is that a false sense of security is experienced, as it anaesthetizes the sensory organs and the characteristic offensive odour gradually disappears.

5.2 Risk Assessment and Risk Avoidance

Hazards can exist without significant risk to health. Aerosol spray droplets below 5 μm in diameter are inhalable but if fine aerosol formation is avoided, there is virtually no risk. Such aerosol formation is most likely to occur during tank cleaning and approved masks should be worn.

Small concentrations of hydrogen sulphide in a water phase equilibrate with very high concentrations in the air phase, rising to dangerous levels within enclosed spaces. At 25°C, with a quantity of 2.5 ppm aqueous H₂S concentration, this equilibrates with 700 ppm air concentration, which is rapidly lethal, as indicated in Figure 5.2.

Aqueous H ₂ S ppm	In Air H ₂ S ppm
0.5	140
1.0	280
3.0	560
3.0	850
4.0	1140

A 10°C rise in temperature increases in air H₂S ppm by 22%

Figure 5.2
Equilibrium of hydrogen sulphide in enclosed spaces at 25°C

A simple strategy to minimise the risk is to add alkali to ensure an alkaline pH. Hydrogen sulphide and HS⁻ ions are always in equilibrium according to pH as indicated in the Figure 5.3.

pH	Aqueous H ₂ S mg/l	HS ⁻ mg/l
6.0	3.6	0.4
7.0	2.0	2.0
8.0	0.4	3.6

The HS⁻ ion is effectively non-toxic

Figure 5.3
Dissociation of hydrogen sulphide in water in relation to pH

Dangerous accumulation of hydrogen sulphide within enclosed spaces should be avoided. If heavy infection is identified, the use of a biocide should be applied. Ventilation is certainly not a guarantee of safety, as SRB will continue to generate hydrogen sulphide until they are killed – thus entry into a contaminated region is not advisable.

5.3 Biocide Chemicals

Biocides which are used to kill or suppress microbial growth are themselves toxic chemicals and COSHH assessments may regulate their use. They must be used judiciously, ensuring that the crews' health and safety is not jeopardised. Also, they may be environmentally unacceptable. Their proper safe use should be in accordance to the Health and Safety material data sheets supplied by the manufacturer. If biocide treated bilge water is transferred to a sludge barge, the operator must be made aware that he is handling and disposing of a toxic chemical to ensure that the correct neutralising chemical is applied. Ships which pump chemical treated bilge water into the open sea will do so through an oil/water separator. The effects on this equipment must be considered, to ensure that the discharge limit of 15 ppm is not exceeded.

5.4 Test Kit Disposal

Most onboard test kits employ a culturing incubation stage, whereby microorganisms from a sample are encouraged to replicate on a nutritive agar gel, in order to give a visible indication of their presence.

The hazard presented by microbial cultures is many times greater than the hazard posed by the same microbes when in the sample or system. Care should be taken to avoid direct contact with the cultured microorganisms. Before disposal, the cultures should be immersed in a strong disinfectant solution for at least a day. They may then be discarded with normal waste in accordance to the manufacturer's instructions for the disposal of test kits safely.

6. CASUALTIES

6.1 Human Casualties of Microbial Contamination

Recreational, potable and process water including air conditioning systems are all able to nurture microorganisms, including *Legionella*. Awareness of those conditions which aggravate microbial contamination and growth and of the possible infection routes can suggest sensible control measures.

The Merchant Shipping Notices M.1214, M.1215 and 1216 highlights and introduces measures for designing, maintaining and disinfecting these systems.

Microbial Contamination: Microorganisms can flourish and proliferate in dirty water, particularly when it is warm. In clean water, luxuriant growth is not possible but many microbes survive nonetheless and a few manage to reproduce slowly on scant nutrients – for example, trace nutrients remaining in distilled water.

We now know that the organisms we find suspended in water are only a pale reflection of those really present in a water system, as the bulk of the microbial population is present in the films which cover all surfaces. On these surfaces, traces of nutrients are absorbed and aggregate, sustaining those passing microbes which settle there.

A biofilm is built up comprising a mixed flora of interdependent species embedded in a matrix. This biofilm protects as well as nurtures microorganisms. Anti-microbial chemicals are usually many times less effective against biofilm organisms than against the same organisms in suspension. This is particularly so for chlorine, the traditional disinfectant for water systems. Fortunately, the true disease organisms are so adapted to the temperature and the nutrients of their animal host that they cannot proliferate in water systems; they may, however, survive sufficiently long to become a health hazard. The 'opportunistic' pathogens which can flourish in man or water are the ones to be identified.

Microbial contamination of drinking water systems will cause an unpalatable taste and, at worst, an intestinal disease such as cholera or dysentery. Microbial contamination of swimming pools can result in skin infections. Colonisation of hot water systems introduces the risk of Legionnaire's disease *Legionella*. Colonisation of water in air conditioning systems can lead to 'Humidifier Fever' or Bronchial Asthma.

There is increasing public concern about health hazards from water systems and 'The Approved Code of Practice' ACOP, places responsibility on employers for ensuring that disease hazards are avoided.

Microbial Fouling: As indicated, some degree of surface fouling is almost always present. In excess it becomes visible as slime. Less widely known is that severe microbial fouling can occur on Reverse Osmosis (RO) membranes. The RO supplier should proffer decontamination advice depending upon the chemical structure of the membrane. Preference is shown for 0.25%-wt.content hydrogen peroxide because it is safe in drinking water systems and reacts with microbial enzymes, generating oxygen which lifts and disrupts the fouling layer. Carbon filters are sometimes used to remove water contaminants which offend taste. Unfortunately, in doing so, they concentrate nutrients for bacteria and these (including some harmful ones) can survive and even proliferate. Chemical decontamination is extremely difficult as anti-microbial agents are themselves absorbed or deactivated. Steam or very hot water decontamination is feasible if the device is structurally thermo-stable.

Simple filters entrain organisms which may then proliferate. Some modern filter materials incorporate silver as an

insitu anti-microbial agent. If decontamination is not possible, frequent renewal is advisable.

Health Hazards from Water: Microorganisms in water can enter the human body by three routes:

1. Via the digestive tract: contaminated water is a particular hazard as it passes quickly through the hostile environment of the stomach and at the same time dilutes the acid there, thus reducing its anti-microbial properties.
2. Via cuts and abrasions – hence microbes which are not normally invasive can cross the impermeable barrier of the skin.
3. Via airborne droplets: only very small droplets (5 μ m and less) can penetrate into the respiratory system and cause infection of the terminal air passage and air sacs. All of these routes are available on a ship.

Legionella bacteria which causes Legionnaire's disease, have been identified in water onboard ships. All water systems should thus be considered as possible microbial niches and potential hazards, and specific risks should be assessed.

Legionella: *Legionella* is the name given to a genus of bacteria of which *Legionella pneumophila* is one species. It is commonly associated with disease outbreaks and apparently is the most pathogenic of the genus. To date, at least 34 different species of *Legionella* are recognised. This bacterium is common to natural water systems such as rivers, ponds and even wet soil, but unfortunately has now found a new environment in man-made water systems, as these provide particularly suitable conditions for growth. Its appearance is rod-shape and growth occurs between 25-45°C with particularly rapid growth at about 36°C, feeding on the by-products of slime-forming microbes. Hence, any situation which is warm and contaminated with microbial slimes could encourage the proliferation of *Legionella*. It is easily killed in water because it succumbs readily to heat and most disinfectants, provided it is not encased in biofilm. A few *Legionella* bacteria are likely to be detected in most warm, slimy locations, increasing with population. *Legionella* is an 'opportunistic' pathogen – that is, it can only invade a susceptible host and thus, only a potential hazard.

To infect such a host the water containing *Legionella* must be vaporized (to 5 μ m droplets or smaller) and inhaled in considerable numbers. Its detection in small numbers in water is not necessarily a severe health hazard. It would probably be found in half the man-made water systems tested and its presence must be viewed in the light of the likely risk. A water system, which is warm and contains slime, produces a fine aerosol and directs this at a susceptible host, is a high potential risk. There is no person-to-person transmission and most investigations have implicated warm showers or cooling water spray radiators. It is probably not a new disease, but rather a form of pneumonia which may have previously been attributed to other causes. Although there are test methods available for *Legionella* organisms, it is more practicable simply to aim at suppressing development of all microbial slimes, keeping systems free of organic fouling. Direct testing is justified if incidences of disease arise or if a particular high risk situation is identified.

6.1.1 Drinking Water

Fortunately, the rigid standards for water treatment, distribution and storage have largely eliminated the risk of contracting the various enteric diseases which could be disseminated by

contaminated water. No distinction is now made between the chemical treatment of water taken by barge or shore main and water produced onboard.

The latter is frequently generated by a low pressure evaporator which can be heated by steam or engine cooling water. The temperature of the former is high enough to guarantee that, even if the brine is contaminated with microorganisms, they will not survive in the distillate. Evaporators heated by water run at much lower temperatures, possibly as low as 35°C, but evidence suggests that provided the brine strength is $\geq 4\%$ -wt.content, there will be no carry over of living bacteria into the distillate.

To minimise the risk of contamination originating from the brine, it is recommended that the evaporator is only operated when at least 20 miles from land, even further if there is a risk of estuarial pollution. There is potential for contamination by direct leakage from the engine cooling water as this frequently contains very large numbers of bacteria.

Reverse Osmosis is an alternative method of generating fresh water. The membranes may accumulate microbial slimes, but the membrane pore size is small enough to prevent their passage if the integrity of the structure is perfect.

Water produced or taken onboard must be 'sterilised' for use as fresh water. The only treatment now approved by Notice M.1214 is chlorination. It should be remembered that chlorination is only effective at the correct dosing rate, indicated by Notice M.1216 (0.2 ppm residual). There have been cases where lesser concentrations have failed to kill microbial spores when entrained in biofilms.

6.1.2 Domestic Water

It has already been mentioned that shower heads have been found to harbour *Legionella* within slime residues. Accommodation regulations propose a shower water temperature of 35-41°C and it will be seen that this range is particularly stimulatory to *Legionella*. It is readily killed by heat, and routine flushing out with very hot water is a simple control measure. A sensible strategy is to have ring main systems for both hot and cold water supplies to prevent the formation of stagnant warm zones, ensuring that hot water is circulated in a ring main at 60°C. The correct maintenance of equipment and fittings is important, and shower heads and tubes should be super-chlorinated every three months.

Shower drains should be regularly disinfected, as an aerosol of the drain contents can be formed when a spray of water impinges there.

Since *Legionella* are known to accumulate in the lower, cooler part of calorifiers, they should be decontaminated regularly by raising the temperature to 70°C for one hour. Cold water systems should be kept as cool as possible to discourage any growth.

Air humidifiers in which air is directed through a curtain of water droplets are lush environments for microbial growth. Although they are rarely (and arguably) a source of *Legionella* the inhalation of microbe carrying water droplets from humidifiers can give rise to flu-like 'Humidifier Fever'. It is not a true infection and if the source of the droplets (the water recirculating in the humidifier) is cleaned out and disinfected, the symptoms of the sufferers disappear.

Problems associated with domestic water systems are addressed in Notice M.1214.

Swimming Pools: A form of skin granuloma has been associated with swimming pools for many years. The bacterium *Mycobacterium marinum* enters the body through cuts and abrasions in the skin. It has some resistance to chlorine and can survive very well on rough and broken tiles.

Many bacteria from the bathers, particularly skin and faecal organisms, can be found in swimming pools and present a hazard. Sweat and urine pollute the water and stimulate these organisms, whilst rendering many disinfectants inactive. Hence a range of disinfectants based upon chlorine, iodine and bromine are used in swimming pools, at concentrations high enough to kill body originating organisms within one minute. Chlorine-release chemicals such as isocyanurates are frequently used but are not suitable for potable water. Athlete's foot (a fungal skin infection) and certain kinds of warts can be acquired from floor areas around pools: regular cleaning and disinfection are essential.

Jacuzzis and Whirlpools: The potential hazard is much increased as many people occupy a small volume of water held at just above body temperature, usually 38-40°C. There are many recorded instances of skin infection associated with these pools, usually caused by *Pseudomonas aeruginosa*, but more recently attributable to *Legionella pneumophila*. Chlorine treatment of whirlpools is often ineffective due to the heavy organic and bacterial load and to its volatility at this temperature. Bromine-based disinfectants have found favour, but over-dosing can cause skin rashes.

6.1.3 Air Conditioning

Notice M.1215 particularly addresses the potential hazard from *Legionella* in air conditioning systems and emphasises the need to prevent the accumulation of fouling in filters, drains, etc, and for disinfection at intervals of not less than three months.

Fortunately, most disinfectants will kill *Legionella* bacteria and it is most important that the product penetrates slimes and organic deposits and is safe to use.

Chlorination is especially suitable, but it should be noted that chlorine is easily deactivated by gross organic contamination and is not very effective under alkaline conditions.

A three-monthly interval between disinfection regimes is suitable but outbreaks have occurred where such infrequent chlorination has been inadequate. Sensible cleaning and disinfection programmes for systems at risk should have their frequency guided by observable results.

Such measures should aim to keep the total numbers of microbes below 105 per ml of water and a simple on-site device, a dip-slide, can monitor this. It is doubtful, however, whether such monitoring is successful on ships, as there is no universal agreement on what constitutes an acceptable level of contamination.

Pools of contaminated water lying in air condition ducts have been recently implicated in a *Legionella* outbreak. Disinfection of duct-work can be achieved by a 'fogging' disinfectant, but should only be attempted with expert help.

Risk Assessment and Hazard Avoidance: The characteristics of *Legionella* bacteria already outlined suggest the salient factors in risk assessment and conversely the strategies for hazard avoidance. Obvious factors in risk assessment are time and intensity of exposure. A shower has short but concentrated exposure, a spa longer but less intense exposure, and conditioned air presents dilute concentrations for much of the day. Hazard avoidance is largely a matter of negating those factors which stimulate *Legionella*.

It is not of course possible to banish high risk passengers or crew – an ideal avoidance procedure, but everyone should be aware of the heightened need for extra vigilance. Principles of avoidance to be employed can be summarised and used as a checklist for good housekeeping practice, as shown in Figure 6.1.

- 1. Avoid stagnation in water systems.**
 - 1.1 Disconnect redundant piping, wash-basins, showers etc.
 - 1.2 Circulate on a ring main to avoid stagnation in infrequently used installations, particularly showers.
 - 1.3 Connect multiple storage tanks in series, not parallel.
- 2. Keep cold water supplies as cool and clean as possible substantially below 20°C.**
 - 2.1 Locate the storage tanks in a cool place if possible. Ventilate this location.
 - 2.2. If filters are installed, clean and disinfect not less than monthly.
 - 2.3 Insulate cold pipes running through warm locations eg, alongside a hot pipe.
 - 2.4 Superchlorinate system at six monthly intervals and after re-fitting or dry docking.
- 3. Reduce extraneous contamination.**
 - 3.1 Secure proper lids on all storage tanks.
 - 3.2 Repair leaking pipes etc.
 - 3.3 Ensure that no back-flow can occur from dish-washers, washing machines etc.
- 4. Keep hot-water systems hot and clean, but avoid scalding risks.**
 - 4.1 Calorifiers should be thermostatically controlled at 55-60°C.
 - 4.2 Hot water outlets should be above 46°C, if necessary provide trace heating.
 - 4.3 Showers should be self-draining if possible.
 - 4.4. Decontaminate calorifiers regularly by stopping water usage and setting the thermostat to 70°C (preferably 80°C) for several hours. Then run water out slowly through all outlets.
 - 4.5 Superchlorinate shower heads and tubes every three months.
 - 4.6 Disinfect shower drains regularly.
- 5. Keep air-conditioning systems clean.**
 - 5.1 Clean and disinfect filters, drains, etc, every three months.
 - 5.2 Provide air breaks for chiller battery drains.
 - 5.3 Provide inspection hatches to facilitate regular inspection of heat exchangers
 - 5.4 Keep recirculating water humidifiers scrupulously clean.
 - 5.5 Prevent water ponding in ductwork. If necessary disinfect ductwork by 'fogging'.
- 6. Keep fire-sprinkler systems clean.**
 - 6.1 When refilling after discharge use chlorinated water.
- 7. Workshop hazards**
 - 7.1 Legionnaire's disease has occurred from cutting fluid aerosols. Clean and disinfect systems regularly.
- 8. Keep records of inspection, cleaning and maintenance.**

Figure 6.1
Good housekeeping practice

These principles should be adopted as part of a regular routine after bringing the system to an acceptable condition, paying particular attention to constructional materials. Many structural materials, if used in potable water or recreational water systems, can actually encourage growth of microbial slimes. Organisms from the slimes become suspended in the circulating water and hence contribute to the microbial 'load'. The slimes themselves are mixtures of polymers in which the microbes are entrained, and many disinfectants fail to penetrate this complex. Fortunately, constructional materials have been extensively investigated and guidance on the choice of material is readily available. New ships must use approved material and existing ships must progressively replace unsuitable materials in drinking and washing water systems.

A new or extended water system should be cleaned and disinfected before being brought into service. Superchlorination to achieve a free residual of 50 ppm for 12 hrs, followed by thorough rinsing is a suitable procedure.

It should not be forgotten that the act of cleaning contaminated systems can be a hazard. There was an example where ten men contracted 'Pontiac Fever', a form of Legionnaire's disease, after cleaning steam turbine condenser tubes. The requirement is to wear protective clothing, particularly masks, if there is a perceived risk, and disinfect before cleaning. There have been cases of disease, including Legionnaire's disease, associated with water systems on ships. The risks are small but it is necessary to create awareness – as awareness stimulates the proper degree of care and prevention.

6.1.4 Sewage Treatment

The potential health hazards from toxic hydrogen sulphide sewage gases, generated by anaerobic bacteria (SRB) have been highlighted by a recent tragic incident on a ferry. (Notice M.1548). Good design and maintenance are advocated to avoid such occurrences. If there is reason to believe that the potential for such an incident is present, a number of control measures can be considered for preventing corrosion by SRB.

Effective measures include; raising the pH above 8.0, adding hydrogen peroxide to react with hydrogen sulphide to form water and sulphur, or adding simple cheap biocides such as hypochlorite or chlorine. The operational function of the air injectors, ensures that the conditions remain unsuitable for anaerobic bacteria. Ventilation of the gas space will also prevent corrosive accumulations of hydrogen sulphide gas.

6.2 Marine Casualties of Microbial Contamination

Case History No. 1.

Reported Problem: Bilge Main Pipework Corrosion
Microbial Presence: Sulphate Reducing Bacteria (SRB).

Vessel: Cross Channel RoRo Passenger Vehicle Ferry
Built: West Germany – 1987 +100A1

Investigation by FACS

This vessel was the first of two ferries built and suffered corrosion of the bilge main pipework, which was not experienced by her sister vessel.

The bilge system comprised of a bilge main, connecting all spaces from the aft steering space through main and auxiliary machinery spaces, void spaces and forward machinery spaces. In addition, an oily bilge system was provided in the main and auxiliary machinery spaces. The bilge main system was not regularly used and was primarily only tested weekly

as part of the vessel's routine maintenance and for re-certification purposes annually.

Corrosion in the bilge main pipework first came to the attention of vessel's staff in 1991, the pipework being fully welded throughout. The problem first manifested itself as a loss of suction due to perforations in the pipewall during routine testing, as shown in Figure 6.2.



Figure 6.2
Bilge main perforations of pipewalls due to SRB corrosion

This prompted renewal of 20% of the bilge main system at the vessel's annual survey and dry docking in early 1992. Any remaining pipework was renewed at the next annual survey and drydocking in early 1993, where it was noted that corrosion was evident in pipework that had been renewed in 1992. Total costs of this renewal programme amounted to £95,000.

Vessel's staff are required to maintain machinery spaces to a high standard of cleanliness; leaks and spills are thus kept to a minimum and bilges do not require regular pumping. Unfortunately, bilge pipe work is liable to become stagnant without pumping, leading to a consequential risk of microbiological corrosion.

Since only one of the two vessels had suffered this corrosion problem, onboard procedures were reviewed. The reason was mainly due to the fact that the sister vessel's staff tested the bilge main by flooding and pumping the system through with fresh water. This testing principle has now been adopted and although there is a periodic odour of hydrogen sulphide present, the incidences of corrosion appear to have abated.

Evaluation

Implementation of onboard procedures to prevent further stagnation of water in the bilge main pipework, has prevented further SRB corrosion problems.

Case History No. 2.

Reported Problem: Ballast Tank Corrosion.
Microbial Presence: Sulphate Reducing Bacteria (SRB)

Vessel: Cross Channel RoRo Passenger Vehicle Ferry
Built: Denmark – 1976 +100A1

Investigation by FACS

The vessel suffered corrosion in the double bottom ballast tanks after it was lengthened in 1986, and the tanks newly painted.

Three of the six ballast tanks affected were situated amid-ship. These tanks were not regularly used, remaining empty and closed between refits. Corrosion of the ballast tanks was first noticed by the vessel's staff in 1986, shortly after the ship returned to service.

During ballasting, polluted water containing effluent discharged from a fish meal factory close to the repair berth, was pumped onboard. Corrosion had been further exacerbated by water ingress through the Winner ball valves with defective seals.

An ongoing replacement programme to remedy the leaking valves is being carried out during annual refits. The corrosion and deep pitting damage, which consisted of pits up to 10 mm in diameter, has led to ongoing weld repairs to the steel work, costing some £8,000 per year.



Figure 6.3
Ballast tank corrosion by SRB due to fish oil protection coating before cleaning



Figure 6.4
Ballast tank corrosion indicating extent of steel wastage after cleaning

The reason for the acceleration in corrosion is due to the fish oil coating the newly painted tanks. Since SRB are dependent upon an oxygen depleted environment, the oil film barrier effectively accommodated this requirement. Aerobic bacteria in the polluted water, being adequately sustained by the nutrients from the oil, penetrated the oil film barrier which, in turn sealed behind them. Establishment of SRB between the paint and oil film barrier, prevented oxygen from entering and their acidic by-products dissolved the protective paint, exposing and corroding the underlying steel, as shown in Figure 6.3.

Evaluation

Application of a cleaning degreasant to remove any remaining oil film, followed by biocide dosing, should prevent further corrosion. This is dependent upon the degree of steel wastage, depth of pitting and rust scale, which should be removed to expose the SRB to the biocide, as shown in Figure 6.4.

Case History No. 3.

Reported Problem: Gas Oil Cargo Contamination.

Microbial Presence: Aerobic Bacteria, Yeasts and Moulds.

Vessel: Product Tanker.

Built : Sweden – 1975 +1A1

Investigation by FACS

The vessel had loaded a microbial contaminated gas oil cargo of 13,000 tons from the Baltic port of Ventspil in November 1993.

Routine testing of vessel's cargo before discharge in Rotterdam confirmed the presence of severe microbial infection. After the cargo was declared spoilt, it was subsequently discharged. Since the discharge, the vessel had implemented tank cleaning procedures with chemical dosing to eliminate the continued presence of microbial contamination, without success.

Cargo samples received from the vessel enabled the types of microbes to be identified and the choice of biocide. The microbial count for bacteria, yeasts and moulds measured greater than 25,000 in a litre sample. Onboard assessment of the operating problems, tank layout, piping systems and the available stand-down period, allowed a tank decontamination and time schedule programme to be planned and implemented, as shown in Figure 6.5 and Figure 6.6.



Figure 6.5
Viable microbial biofilms adhering to cargo tanks before biocide decontamination



Figure 6.6
Dead microbial biofilms floating on water
after biocide decontamination

Cold water, dosed with the correct biocide concentration, and circulated using the high pressure Butterworth system, at 1, 4 and 8 metres from the tank tops, dislodged the adhered biomass films from the tank walls. Further soaking of each tank, ensured that the biocide kill time of 6 hours was achieved, such that the entire operation was completed in 48 hours. Direct and indirect costs due to loading a contaminated cargo and decontaminating the vessel were in the order of £70,000, which exceeded the freight rate profit in carrying the tainted cargo.

Evaluation

Application of the correct biocide and strategies to eliminate the persistent microbial infection proved effective and a 'microbial free cargo tank' report was awarded to the vessel. Until such a report was issued, the vessel was not acceptable to charterers.

Case History No. 4.

Reported Problem: Gas Oil Fuel Contamination.

Microbial Presence: Aerobic Bacteria, Yeasts and Moulds.

Vessel: Patrol Ship.

Built: Denmark – 1960 +100A1.

Investigation by FACS

The vessel loaded gas oil bunkers from an Icelandic port in 1994 and in accordance with their procedures, used one of the settling tanks to store the fuel, until a sample was analysed as being 'fit for use'.

Evaluation

Analysis of the sample received indicated that the gas oil was unsuitable for service due to severe microbial infection, as shown in Figure 6.7.

Had the vessel used the fuel, the spoilage material would have caused filter blockage. The vessel duly offloaded the fuel and implemented a cleaning and biocide treatment programme. In this instance, all costs were against the supplier.



REPORT

Lubricant Quality Scan
 Telephone 081-681 4040
 Telex 8953603 LR LON G
 Fax 081-681 4056

SITE OR VESSEL:
 XXXXXX

FUEL SAMPLE

LR OR SITE NUMBER:
 XXXXXX

EQUIPMENT TYPE: MAIN ENGINE
 MANUFACTURER: B & W
 MODEL: 9 - 35VBF - 62
 FUEL GRADE: GAS OIL

CLIENT: XXXXXX

SAMPLE NO:	LQS/115770/RAS	
SYSTEM SAMPLED:	SETTLING TANK	
SAMPLING POSITION:	DRAIN LINE	
DATE SAMPLED:	01.11.94	
DATE DISPATCHED:	01.11.94	
DISPATCHED FROM:	ICELAND	

METHODS (ticked as appropriate):

1 DAY REPORT (MICROBIAL PARTICULATE ASSESSMENT):

- VISUAL ASSESSMENT
- MICROSCOPE EXAMINATION OF VISIBLE PARTICULATE DEBRIS
- FUNGAL FRAGMENT COUNT

5 DAY REPORT (MICROBIAL VIABLE ASSAY):

- BACTERIA, YEASTS, MOULDS & SULPHATE REDUCING BACTERIA (SRB) IN FUEL PHASE (MODIFIED IP385; EXCEPT FOR RESIDUAL FUELS WHICH USE AN EXTRACTANT METHOD)
- BACTERIA, YEASTS, MOULDS & SULPHATE REDUCING BACTERIA (SRB) IN WATER PHASE

MICROBIAL ANALYSIS RESULTS

COLOUR APPEARANCE WATER VISIBLE DEBRIS	GREY/YELLOW TURBID NO FREE WATER LARGE AMOUNTS - FINE DEBRIS	
MICROSCOPIC EXAMINATION:	LARGE AMOUNTS - SMALL WATER DROPLETS AND MICROBIAL MATERIAL	
VIABLE MICROBES IN FUEL AT 25°C (PER LITRE) BACTERIA YEASTS MOULDS SRB	GT. 10000 (c.10 ⁶) GT. 10000 GT. 10000 GT. 10000	
VIABLE MICROBES IN WATER AT 25°C (PER ML) BACTERIA YEASTS MOULDS SRB		
FUEL CONDITION	D A = Suitable for further service B = Preventative action Required C = Remedial treatment required D = Unsuitable for further service	

COMMENTS

FUEL CONDITION:

Fuel is unsuitable for further service. The analysis of this sample indicates very severe microbial infection and the spoiling material is likely to cause filter blocking. Purification is unlikely to resolve the problem. The presence of SRB is of particular concern and may be corrosive to fuel system components and fuel tanks.

ACTION:

We recommend the fuel is removed from the system and the tanks inspected, then manually cleaned to remove sludge, slime and sediment. After cleaning new fuel should be dosed with an appropriate fuel soluble biocide, then circulated around the system.

Further samples should be taken after decontamination to identify any viable microbial presence.

Date of Next Sample: Immediately after decontamination.

Report Date: 08.11.94



Figure 6.7
 Severe microbial infection in loaded gas oil

7. TESTING FOR MICROBIAL PRESENCE

In view of the current increase of widespread infection, there is a strong case for routine sampling and analytical tests to be carried out onboard and supported by a comprehensive laboratory report.

The primary function of an onboard microbiological test is to provide an early warning to pre-empt microbial infestation. It can also be used to verify microbiological activity and to demonstrate that the microorganisms involved are still viable.

However, even within the same location, there will be variations in the types and number of microbes present at specific points. This can change with time due to changes in aeration, pH, temperature and nutrient availability. *In situ* tests need therefore to be able to detect a wide variety of microorganisms, identify them as being bacteria, yeasts or moulds and indicate particularly whether sulphate reducing bacteria (SRB) are present; all of this information should be expressed at least semi-quantitatively. At present there is no test which can achieve this and instead an informed choice must be made from the test kits which are available, in order to investigate any problems (or potential problems) and then monitor the efficiency of subsequent anti-microbial strategies.

All *in situ* tests require an incubation period; this could be a matter of minutes for initiation or days to monitor microbial growth. The tests should be incubated either at or near the temperature of spoilage, or at the temperature prescribed for a particular test.

Aerobic and anaerobic microbes are usually tested for separately. Facultative microbes are able to grow aerobically

or anaerobically and will therefore be detected whether or not oxygen is present.

7.1 Onboard Test Kits

There are numerous types of onboard dip-slide test kits available and they all identify the degree to which microbial contamination is present. They are usually only able to test aqueous samples and are of the following design:

A small plastic paddle (approx. 2 x 5 cm), coated with a nutritive agar gel is dipped into an aqueous sample or the sample is applied to it. Some of the microbes adhere to the gel and reproduce during incubation to yield visible spots which are colonies. The pattern of spots is compared to a calibration chart and the initial number of microbes is read off the chart, as shown in Figure 7.1.

It should be noted that the calibration and dip-slides have been designed for aqueous samples; the chart will give misleading information if the slide is dipped into or through fuel or lubricating oil. Sterile disposable 1 ml Pasteur pipettes can be used to access water below a fuel sample and apply it to a slide; the original calibration is then valid.

Some nutritive agars are designed to grow bacteria, whilst others grow moulds and yeasts, but neither type do this exclusively. Some dip-slides will have different types of agar on opposite sides of the slide.

Test for Bacteria: Most dip-slides for bacteria incorporate a dye which stains the bacterial colonies red. The slides are incubated in a warm room for 2-3 days and the result read without opening the container, as shown in Figure 7.2.

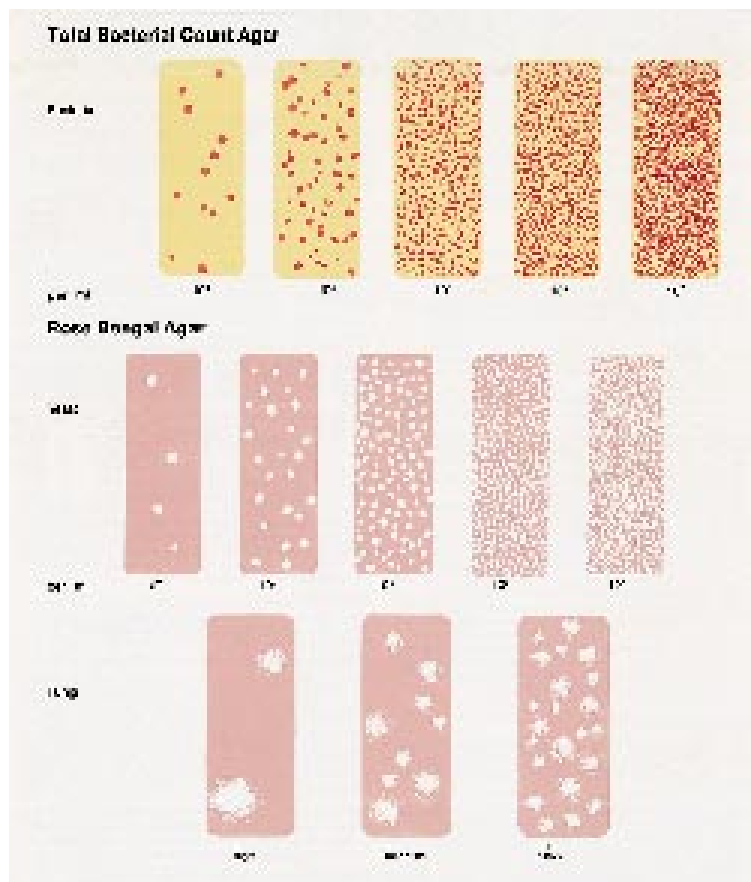

Figure 7.1
Bacteria, yeast and mould colonies on test kits

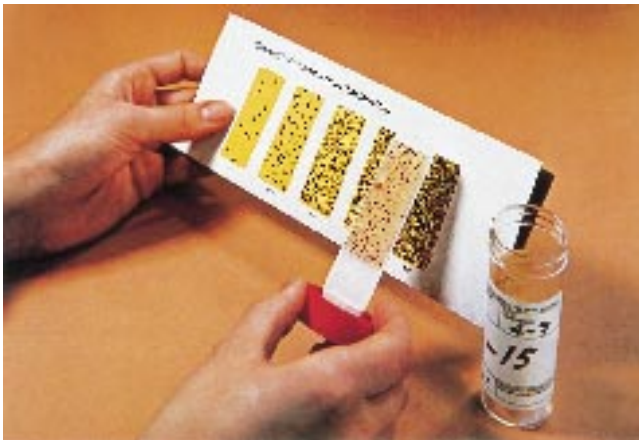

Figure 7.2

Evaluating bacteria counts against calibration chart

Typical numbers of colonies expected per ml sample are:

Potable water	0 -10 ²
Clean sea water	10 ² -10 ³
Polluted water	10 ³ -10 ⁴
Lightly infected fuel in water bottom	10 ⁵
Heavily infected fuel in water bottom	10 ⁶ -10 ⁸

Test for Moulds and Yeasts: Agars designed for yeasts and moulds will grow the former as round colonies, coloured white, cream or red. After incubation for 3-5 days under warm room conditions, the result is read from the calibration chart. Yeasts are usually less than those of bacteria.

Typical numbers of colonies expected per ml sample are:

Potable water	0
Clean sea water	0-10 ²
Polluted water	0-10 ³
Lightly infected yeasts in fuel water bottom	10 ³ -10 ⁴
Heavily infected yeasts in fuel water bottom	10 ⁴ -10 ⁶

Moulds cannot be quantified in the same way as bacteria and yeasts; a single mould may be in the sample as a minute spore (not significant) or a 'mat' of proliferating strands. Incubation for yeasts is similar. Colonies are seen as large 'furry' patches, usually cream, green or grey/brown in colour. Should any yeasts or moulds be detected, evidence of growth mats in the sample should be looked for. If in doubt, professional help should be sought as the identity of the moulds is important.

It should be noted that some agars designed for yeasts and moulds contain the dye Rose Bengal, which colours the colonies pink and masks their real colour. Rose Bengal is affected by undue exposure to light, after which it tends to suppress colony development. Thus, a slide should be checked with a sample known to contain yeasts or moulds (real ale or stale milk can be tried).

Tests for SRB: These microbes grow only in the absence of oxygen and, therefore, an aqueous sample is pushed into an agar gel using a glass tube, a pipe cleaner, or is simply poured on top, as shown in Figure 7.3.

The degree of infection is determined by the rate of development and intensity of a black coloration. All should be incubated in a warm room for up to 10 days. Any positive result should be viewed with concern as SRB plays a prominent role in accelerating corrosion of steel and yellow metals.

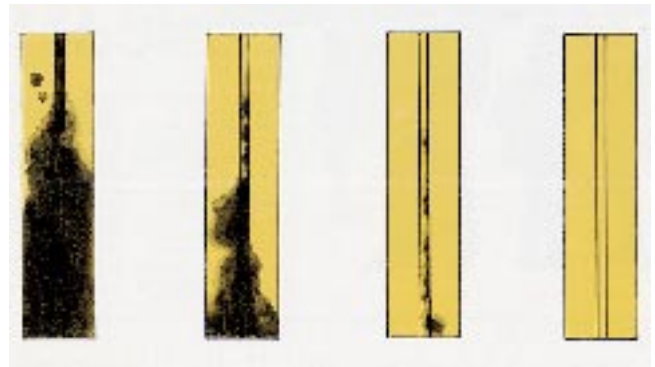

Figure 7.3

SRB growth resulting in the formation of black iron sulphide

Tests on Water-free Samples: There is no simple onboard test which can be used directly to detect microbes in the fuel and lubricating oil phase. Available tests rely upon extracting the organisms from the oil phase into an aqueous phase, which is then tested. Organisms in the fuel and lubricating oils are extracted into sterile water with a flocculant and then transferred to an agar gel, which detects their presence by a colour change in 1-3 days. The extraction bottle, sterile transfer pipette, and sensitive gel are all supplied with the kit. Very slight contamination may not be detected, but more numerous organisms will induce increasing colour changes in the gel.

Tests on Surfaces: Dip-slides can be pressed against tank surfaces and then incubated to obtain an indication of cleanliness. The calibration charts are irrelevant in strict terms of numbers, but a slide corresponding to 0-10² on the chart would indicate a reasonably clean surface and one corresponding to >10⁶, a very dirty surface. This is a useful strategy to check the efficacy of a decontamination procedure. Surface guideline limits are shown in the Figure 7.4.

Microbes	Chart Reading	Surface Condition
Bacteria	10 ⁵ 10 ⁶ 10 ⁷	Moderate Moderate/heavy Heavy
Yeasts	10 ⁴ 10 ⁵ 10 ⁶	Moderate/heavy Heavy Very heavy
Moulds	Interpret as per calibration chart	

Figure 7.4

Surface guideline limits

Most fuel infections involve bacteria, but in some cases the dominant organisms are yeasts and moulds.

7.2 Sampling Procedures

The exact sampling point is important and affects the interpretation of any test. Most microbial growth will probably be at the oil/water interface and SRB are usually closely associated with steel surfaces, particularly the tank bottoms. These

microbes, when in contact with surfaces will adhere as a biofilm. Comprehensive information should be recorded, including the temperature of the system sampled, precise sampling point and the recent history of the system. If samples are sent away for testing, they should be kept as cool as possible (but not frozen) and transported by the quickest practical route.

Fuel Oil:

When to sample bunkered fuel

1. Routine analysis of bunkering provides evidence for claims against suppliers if problems are detected.
2. Routine testing will allow detection of contaminated fuel at an early stage and allow appropriate remedial treatment, hopefully before operational problems occur and before transfer between tanks.
3. Analysis of fuel bunkered at previously unused facilities, in areas where problems have been encountered, or at facilities known to have caused problems.
4. Less frequent analysis of bunkerings from facilities previously free of contamination should also be considered. A few samples giving negative results does not necessarily give a bunkering facility a clean bill of health.
5. When operational problems are encountered, or onboard contamination is significant, samples should be made available for laboratory analysis. Collecting several sets of sealed samples by a reputable independent laboratory will aid consequent claims against the supplier.

Where to sample bunkered fuel

Microbial contamination in fuel tends to distribute heterogeneously. It settles out towards the bottom, but may easily be re-distributed with fuel movements.

1. A good sample is one containing water i.e. a drain sample from the storage tank, road tanker, barge. If water is recovered, a one hour test can be used enabling rapid detection of potential problems. Even if water is not recovered, a sample from the bottom of the supply tank is most likely to reveal contamination, although this sample will not be suitable for rapid analysis. Bottom samples from supply tanks will not represent overall contamination in bunkered fuel. Analysis of samples from higher layers may fail to detect a gross bottom contamination which could be re-suspended in upper fuel layers during bunkering and lead to subsequent operational problems.
2. In addition to bottom samples, a sample which represents the bulk of bunkered fuel is advisable. If it is not possible to sample from a point prior to delivery onboard, a sample from the loading pipeline, hose or manifold is another option. Wherever possible, sample both at the beginning and end of bunkering.
3. A sample from the ship's bunker tanks or bunkering pipelines is a third, but less preferred option. Tests on this sample will not enable the source of contamination to be pin-pointed, since it will not reveal whether it originated from bunkered fuel, pipes or was present in the ship's tanks prior to bunkering. Samples should not be taken from dead legs of loading pipework, as these are unlikely to be representative. Samples are only appropriate if they are taken from the actual batch bunkered and a single sample is rarely adequate. For example, a composite fuel sample indicates the quality of the fuel in use whilst a bottom sample is useful for predicting future problems.

When to sample onboard fuel

Proliferation of microbial infection from low numbers to numbers likely to cause problems is not rapid, usually taking several months provided that free water is eliminated.

1. For routine monitoring, three monthly sampling of engine room tanks should be sufficient.
2. If problems of water accumulation in engine room tanks are observed, ships are trading in warm climates or filter blocking problems are encountered, sampling rates should be stepped up.
3. In general, main storage tanks need only be sampled every six months and miscellaneous tanks, auxiliary tanks, lifeboat tanks, require only annual sampling.

Where to sample onboard fuel

1. Drain samples from daily service tanks and settling tanks will provide indications of any imminent operational problems.
2. For bunker tanks, use bottom sampling equipment; otherwise sample from delivery lines to engine room tanks or a centrifuge water discharge.

Lubricating Oil:

When to sample

1. Before, after and during lay up.
2. If operational problems or oil specification changes are detected.
3. Routinely for slow speed diesel engines, usually at six monthly intervals, depending upon the ship's history and purifier efficiency.
4. When purchasing or chartering a ship.

Where to sample

1. Crankcase lubricant should be sampled from the sump bottom using water droplets taken from the sounding rod.
2. Before the purifier heater and after the purifier.
3. From a point supplying the engine.
4. Renovating and storage tanks.
5. Other systems and from the dead bottoms of tanks, where water and sediments can collect, as shown in Figure 7.5.



Figure 7.5
Storage tank contamination indicating biofilms and SRB pitting corrosion

Bilges:

When to sample

Bilges should be tested routinely at three monthly intervals or more frequently.

1. If bilges are held onboard for several weeks due to discharge regulations.
2. For ships operating mainly inshore. Unusual operating conditions and periods of inactivity.

- Whenever accelerated corrosion is observed in bilges or pipelines.
- If a sulphide smell is noticed.

Where to sample

SRB activity at the inner steel surface can be identified by correct sampling, as shown in Figure 7.6.

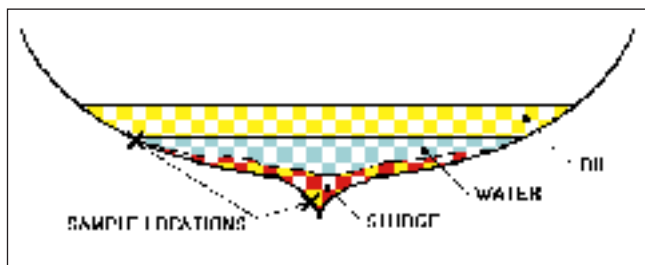

Figure 7.6
Correct sampling position in bilges

- Sample deep bilge bottom sludge.
- Additionally, sample steel surfaces at the water / oil interface, as high level microbial activity may be present.
- If corrosion is observed, sample by scraping sludge or water from the crevice pits. This is best carried out *insitu* as exposure to air and drying results in the eradication of SRB, as shown in Figure 7.7.

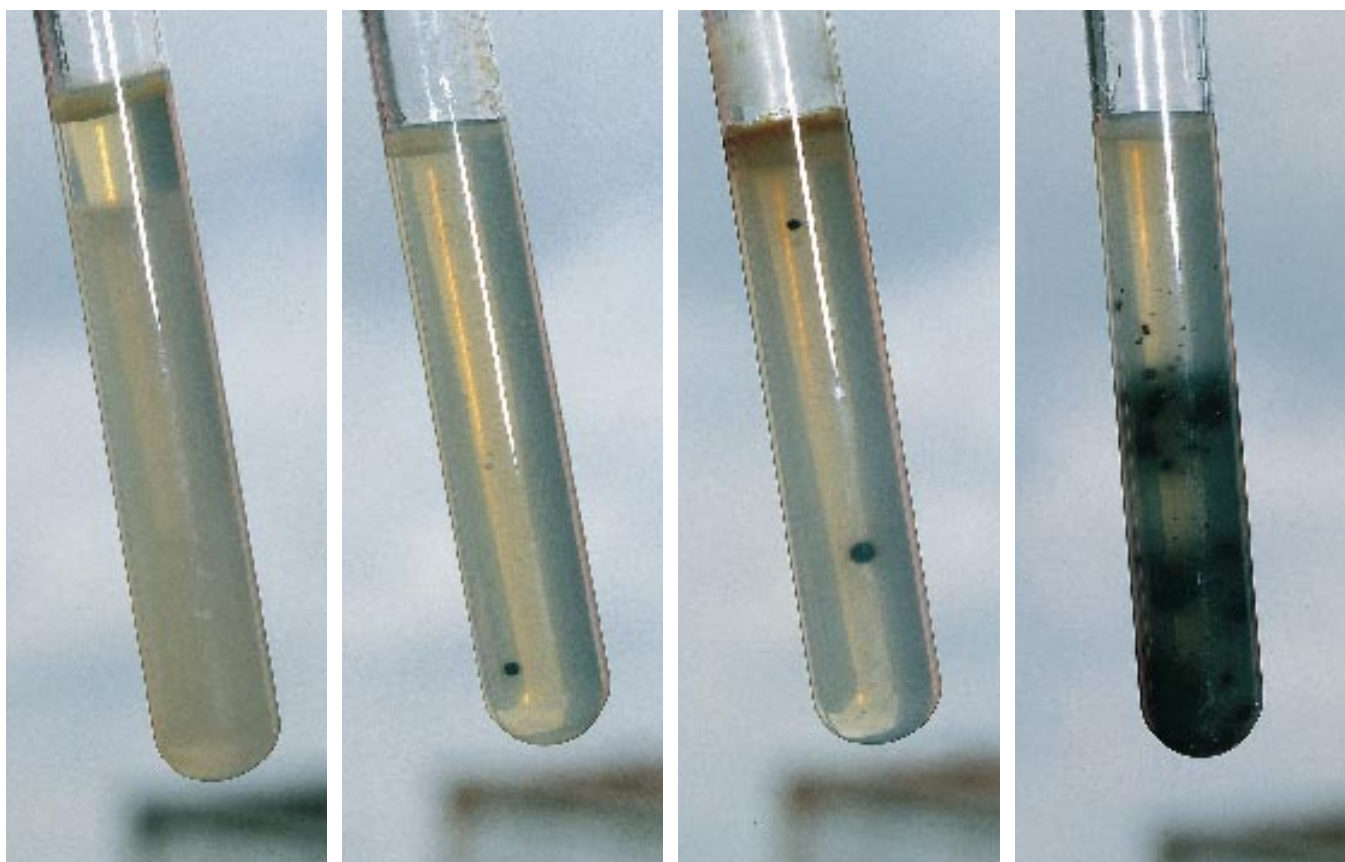

Figure 7.7
Progressive growth of SRB in a culture test from single cell to heavy contamination

Cooling Water:

When to sample

- Routinely, if the pH level reduces.
- If the system is being continuously filled due to leaks.
- When the cooling water smells, becomes discoloured and slime is present.

Where to sample

- From the bottom of the tank to check for the presence of SRB.

Distillate Cargoes:

Sampling fuel cargoes

Sampling techniques used to draw samples for testing, for other cargo specifications and bunkered fuel are appropriate. Microbiological tests on composite top, middle and bottom samples are more representative than those conducted upon a running sample. An absolute bottom sample is also advisable, preferably one containing water, as shown in Figure 7.8. The water may be tested by rapid methods and then passed to a laboratory if contamination is indicated.

7.3 Interpretation of Results

Onboard test kit methods often indicate variations when oil phase samples are tested, being designed to test aqueous samples. However, it should be remembered that each test method is suited to its particular requirement.

Fuel Oil: Fitness for use of a fuel is a function not only of the numbers of microorganisms present but also dispersion of microbial fouling products in the fuel. A limit figure is probably



Figure 7.8
Bottom sampling device

10,000 per litre, although there will be occasions where fewer can be the direct or indirect cause of operational problems or when more do not give rise to operational problems. Fuel oil guideline limits are shown in the Figure 7.9.

Lubricating Oil: It is not possible to cover all test results for each oil system in which microbial problems could arise onboard. Similar tests and interpretations could be relevant for turbine oil, gear oil and hydraulic oil systems. The results and interpretations from a crankcase oil system of a slow speed diesel engine have been taken as an example.

Microbial growth in crankcase oils is suppressed by the proper functioning of the purifier and heater. Its performance as a 'pasteuriser' is easily checked by testing samples of oil before the heater and after the purifier. All other system tests should be carried out at the temperature of the oil after the cooler. Storage tank drain samples should be tested at 20-28°C. These lubricating oil guideline limits are shown in Figure 7.10 and Figure 7.11.

Cooling Water: The cooling water should be tested on a routine maintenance basis. Tests should be carried out at the

TANK BOTTOM	ACTION
Category A < 500 per litre.	Acceptable
Category B 500-1000 per litre.	Warning level. Microbial proliferation may be occurring. Investigate by further sampling and testing.
Category C 1000-10,000 per litre.	Use with caution. Be alert to possible operational problems and spread of contamination. Investigate as for Category B.
Category D >10,000 per litre.	Operational problems and spread of contamination likely. Investigate thoroughly.
Any detection of SRB would be Category C or D. Note: Fuel tested for bacteria, yeasts, moulds and SRB.	

Figure 7.9
Fuel oil guideline limits for fuel in storage tanks

temperature of the water in the header tank. pH levels should be monitored, as a reduction below pH 8-9 will increase aerobic bacteria, resulting in SRB corrosion. These cooling water guideline limits are shown in Figure 7.12.

Bilges: Presence of SRB is always of concern and where tests indicate potential problems, hull plates should be examined for corrosion and possibly biocide treatment after cleaning. When detected, pH measurements should be taken as indicative of corrosion risk, being greatest at slightly alkaline pH. Outside the range pH 5-9, SRB induced corrosion is unlikely as SRB corrosion is associated with a high level of activity by aerobic organisms. The bilge water guideline limits are shown in Figure 7.13.

BEFORE PURIFIER HEATER				AFTER PURIFIER HEATER			ACTION
Bacteria and/or yeasts							
Negative	10 ²	10 ³	10 ⁴ plus	Negative	10 ²	10 ³	
✓	-	-	-	✓	-	-	No action at purifier
-	✓	-	-	✓	-	-	
-	-	✓	-	✓	-	-	
-	-	-	✓	-	✓	-	Confirm heater 75°C plus. Purify continuously.
-	✓	-	-	-	✓	-	Confirm heater 75°C plus.
-	-	✓	-	-	✓	-	Check turnover is less than 10 hours.
-	-	✓	-	-	-	✓	Check retention time is more than 30 seconds.
-	-	-	✓	-	-	✓	The shorter the kill time the more urgent and thorough the action required.
NOTE: If any moulds are detected after the purifier, conduct all the checks listed for temperature, turnover and retention time.							

Figure 7.10
Lubricating oil guideline limits from oil through purifier

SUMP BOTTOM AND/OR BEFORE PURIFIER			BEFORE COOLER OR FILTER			ACTION		
Bacteria and/or yeasts limits			SRB limits		Bacteria and/or yeasts limits			
10 ²	10 ³ -10 ⁴	10 ⁵ plus	No SRB	SRB	Negative	10 ² -10 ³	10 ⁴ plus	
✓	-	-	✓	-	✓	-	-	No action.
-	✓	-	✓	-	✓	-	-	Check coolant. Re-test in one month.
-	✓	-	-	✓	✓	-	-	Decontaminate sump bottom with biocide via sounding pipe. Check coolant. Re-test oil.
-	-	✓	✓	-	✓	-	-	
-	-	✓	-	✓	✓	-	-	Decontaminate sump bottom ASAP. Check coolant. Re-test oil.
-	✓	✓	✓	-	-	✓	-	Decontaminate system when convenient. Check coolant. Inspect for corrosion. Re-test oil.
-	-	-	✓	-	-	✓	-	
-	✓	✓	-	-	-	-	✓	Decontaminate system ASAP. Check coolant. Inspect for corrosion. Re-test oil.
-	✓	-	✓	-	✓	✓	-	
-	-	✓	-	-	-	-	✓	
-	-	-	✓	-	-	-	✓	

NOTE: If any moulds are detected in the sump bottom but not in the circulating oil, sterilise the bottom via the sounding pipe. If moulds are detected in the circulating oil, sterilise the system and inspect carefully for corrosion.

Figure 7.11
Lubricating oil guideline limits from oil in circulation

Tank Bottom	Action
Category A: <10 ² per ml	Acceptable.
Category B: 10 ³ per ml	Warning level. Raise pH level. Biocide routine dose.
Category C: >10 ⁴ per ml	Decontaminate system. Biocide shock dose.
Any detection of SRB would be Category C. NOTE: Water tested for bacteria and SRB. For correct use of biocides see section 4.2.	

Figure 7.12
Cooling water guideline limits in header tank

Bottom Plate	Action
Category A: <10 ² per ml	Acceptable.
Category B: <10 ⁴ per ml	Warning level. Monitor pH. Biocide routine dose.
Category C: <10 ⁶ per ml	Decontaminate system. Clean bilges. Biocide shock dose.
Any detection of SRB would be Category C. NOTE: Water tested for bacteria and SRB.	

Figure 7.13
Bilge water guideline limits for water/sludge on bottom plates

8. STANDARDS

There are no agreed or regulatory microbiological standards which can be applied to either fuel or fuel water bottoms, lubricants, bilges and ballast water.

With regard to fuel; microbial contamination limits in relationship to possible operational problems can only be assessed as guidance values.

1. Clean seawater contains approximately 10^3 bacteria per ml but these are unlikely to be a hazard;
2. Polluted harbour water will probably contain 10^4 bacterial per ml, and they will probably be much more adapted to fuel tanks.
3. Thus, an arbitrary limit of 10^5 microbes per ml could be set for tank water bottoms, with the stipulation that no SRB must be detected.
4. Heavily infected fuels will probably have tank water bottoms containing 10^6 - 10^8 microbes per ml and these may be a mixture of bacteria, yeasts and moulds. Again, their by-products will probably be more significant than the microbes themselves, as bacteria migrating into the fuel may survive for hours or days; moulds and yeasts may survive for weeks. Good clean fuel contains few viable microbes, perhaps only 10-50 per litre. The presence of hundreds of viable microbes per litre is suspicious and thousands should certainly give rise to concern.

A figure frequently quoted as a limit for fuel is 500 microbial particles per litre but exceeding this does not necessarily render a fuel unacceptable. However, since microbiological tests quantify living organisms in fuel, there will be many more undetected dead microbes and biomass which might, if filter blocking occurs, render the fuel 'unfit for use'. It would require microbial polymer and dead microbes to be estimated by chemical tests for polysaccharide and protein respectively, as shown in Figure 8.1.

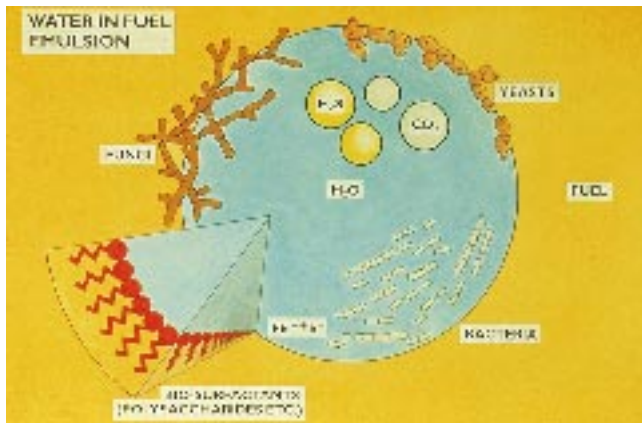

Figure 8.1
Identification of viable microbial contamination by chemical tests

9. CONCLUSION

Microbial fouling and corrosion are becoming commonplace onboard and will probably continue to increase due to fuel oil formulation and handling trends, polluted harbour waters plus regulatory pressures. Ship design and building should recognise these facts, so that systems are designed to be less conducive to harbouring microorganisms and more readily sampled and decontaminated if problems are experienced. Comprehensive onboard test kits are available for detecting and quantifying microbial contamination and for monitoring the success of anti-microbial measures.

There is a growing awareness by underwriters that microbial damage claims are not due to an 'act of God' but are detectable and avoidable. An onboard testing regime would provide good evidence that due diligence had been exercised.

Various strategies are available for reducing the problems but solutions must be safe and environmentally acceptable. The details needed to build these strategies into full working protocols will depend upon individual circumstances, the time available and access to anti-microbial agents. There are many different microbiological problems which need to be met with specific, tailored solutions. However, there are certain common principles of good practice which can be implemented. These anti-microbial strategies are detailed in this paper and have proved to be successful in the field. Briefly recapping, these are:

Physical Prevention: preventing ingress of inoculating microbes, particularly those already adapted to growth in relevant environments. Avoid spreading contamination by passing clean fluids through contaminated pipes, filters and into dirty tanks. Minimize conditions which encourage microbial growth and water.

Physical Decontamination: settling, heat, filtration and centrifugal procedures all aid in decontamination, the choice depending upon equipment and time constraints.

Chemical Prevention: protecting against minor contamination, coupled with good housekeeping to prevent rather than cure infection.

Chemical Decontamination: a wide range of chemical biocides is available. Only a few are appropriate to each specific application, there being no universal eradication fluid. All are toxic and must only be used with due regard to health and safety and environmental impact.

FACS role in this important area of prevention by condition monitoring and cure from investigations, has become an acceptable and desired service to ship operators.

Such is the scale of the problems being encountered within the marine industry, that ship operators have expressed their growing concern. Microbial investigations by FACS has identified, that we are no longer just looking at dirty fuel oil, crankcases, blocked filters etc, but that microbial contamination is now compromising the safe operation of the ship.

To identify the nature, frequency and direct costs relating to the replacement of contaminated cargoes, spoiled fluids or products, also indirect costs from delays, off-hire, repairs, biocides etc, a questionnaire was compiled for circulation to ship operators, as shown in Appendix A.

The response will assess the extent of the microbial problems encountered worldwide. Depending on this response and an independent assessment by FACS, consideration must be given to introduce a research and development

programme, the results of which will provide the information to introduce microbial guidelines into Lloyd's Registers 'Planned Maintenance Schemes'.

10. ACKNOWLEDGEMENTS

The author would like to thank the members of The Institute of Marine Engineers Microbiological Technical Sub-Committee, for their help in providing input to the paper. The Institute of Petroleum Microbiological Fuels Group Committee and Institute of Corrosion Microbiological Corrosion Unit Committee are thanked for their useful comments. In particular the assistance of Dr. E. Hill, and Dr. P. Sanders is acknowledged in providing data and valuable advice. Finally, thanks to Mr. E. Gardiner for assisting with the research and to Dr. S. Harold for reviewing the paper.

11. REFERENCE & BIBLIOGRAPHY

- 11.1 Holbrook, R.P. and Swindells, N.S., *Lubricating Oil Analysis*, LRTA Paper No. 2, 1990-91.
- 11.2 Gavin, A.G., *Double Hull Tankers*, LRTA Paper No. 1, 1994-95.
- 11.3 Haynes, A.G., *Duplex and High Alloy Corrosion Resisting Steels*, LRTA Paper No. 6, 1990-91.
- 11.4 Crawford, J., *A Guide to Pumping and Piping Arrangements*, LRTA Paper No. 77, 1978.
- 11.5 Lloyd's Register Rules and Regulations for the Classification of Ships.
- 11.6 *Regulations for the Prevention of Pollution by Oil*, MARPOL 73/78 Annex 1.
- 11.7 Department of Transport UK Merchant Shipping Notices M.1214 (1986), M.1215 (1986), M.1216 (1986) and M.1548 (1993).
- 11.8 *Microbes in Fuel, Lube Oils and Bilges; Recognition and Monitoring*, Seminar Workshop Sponsored by Lloyd's Register, Conducted by ECHA Microbiology Ltd, I.MAR.E, 1993.
- 11.9 Hill, E.C. and Hill, G.C., *Microbiological Problems in Distillate Fuels*, Trans. I.MAR.E., 1992.
- 11.10 Sanders, P.F., *Monitoring and Control of Microbes, Cost Effective Ways to Reduce Microbial Corrosion*, Publication Elsevier Applied Science, 1988.
- 11.11 Guthrie, W.G., Elsmore, R. and Parr, J.A. *Laboratory and Field Experience with a Bromonitroalkanol Biocide in Industrial Water Systems*, Chemspec 86, 1986.
- 11.12 Kletz, T., *An Engineer's View of Human Error I*. Chem. E., ISBN 0 85295 265 1.
- 11.13 Smith, R.N., *Microbiology of Fuels*, I.P. Microbiology Conference, 1986.
- 11.14 Chesnau, H. L. and Doris, M. M., *Distillate Fuel; Contamination, Storage and Handling*, ASTM STP 1005, 1987.
- 11.15 Hill, E.C. and Hill, G.C., *Microbial Proliferation in Bilges and its Relation to Pitting Corrosion of Hull Plate of In-Shore Vessels*, Trans. I. MAR.E., 1993.
- 11.16 Smith, R.N., *Bacterial Extra-Cellular Polymers; a Major cause of Spoilage in Middle Distillate Fuels*, I.P. paper, 1988.
- 11.17 Shennan, J.I., *Microbiological Risk Assessments for COSHH*, I.P. Microbiology Conference, 1990.
- 11.18 Sanders, P.F. and Stott, J.F.D., *Assessment, Monitoring and Control of Microbiological Corrosion Hazards in Offshore Oil Production Systems*, NACE, Corrosion Seminar 87, Paper No. 367, 1987.
- 11.19 Cordruwisch, R., Kleinitz, W., Widdel, F., *Sulphate Reducing Bacteria and their Economic Activities*, Society of Petroleum Engineers – USA, 1985.
- 11.20 *Microbiological Degradation of Lubricating Oil*, Mobil Oil., Technical Bulletin, 1981.
- 11.21 *Safe use of Pesticides for Non-Agricultural Purposes*, Health and Safety Commission, Approved Code of Practice, HMSO 1991 ISBN 011 885673 1.
- 11.22 *Cryptosporidium's Persistent Presence for the Water Industry*, ENDS Report 237, 1994.
- 11.23 *The Prevention or Control of Legionellae including Legionnaires' Disease*. Health and Safety Executive, Approved Code of Practice, HMSO 1991 ISBN 0 11 885659 6.
- 11.24 *Control of Substances Hazardous to Health: Control of Carcinogenic Substances; Control of Substances Hazardous to Health Regulation (COSHH)*, 1988. Health and Safety Executive, Approved Code of Practice (L5) 2nd edition, HMSO 1990 011 885593 2.
- 11.25 Report of the Expert Advisory Committee on Biocides, Department of Health, HMSO 1989 ISBN 0 11 321190 2.
- 11.26 British Association for Chemical Specialities. *The Control of Legionellae by the Safe and Effective Operation of Cooling Systems*, A Code of Practice 1989, Sutton 1989 ISBN 0 95 149500 3.
- 11.27 *Swimming Pool and Allied Trades Association Standards for Commercial Spas: Installation, Chemicals and Water Treatment*, Caterham 1986 ISBN 0 94 882401 8.
- 11.28 *Respiratory Protective Equipment – Legislative Requirements and Lists of HSE Approved Standards and Type Approved Equipment*, HMSO 1990 ISBN 0 11 885428 3.
- 11.29 *Respiratory Protective Equipment; a Practical Guide for Users*, HS(G)53 Health and Safety Executive, HMSO 1990 ISBN 0 11 885522 0.
- 11.30 Guidance Note GS5 *Entry into Confined Spaces*, Health and Safety Executive, HMSO 1977 ISBN 0 11 883067 8.

Microbial contamination of ships—is this your problem?

Section 1 ① Vessel _____ LR Number _____

② Company Address _____

③ Contact Name _____ Position _____

④ Telephone _____ Fax _____ Telex _____

⑤ If vessel has not experienced microbial contamination please complete section 1, tick box and return.

Section 2 ⑥ If vessel has experienced microbial contamination please complete sections 1 and 2, tick boxes and return.

⑦ Date of incident _____ Systems Cargo Fuel Lube oil FW Bilge Ballast

⑧ Brief summary of incident _____

⑨ Direct costs (in US\$) \$ _____ Indirect costs (in US\$) \$ _____

⑩ Were microbiological tests conducted before the incident? Yes No

⑪ If yes, list samples tested and results _____

⑫ What remedial actions were taken at the time? _____

⑬ Were microbiological tests conducted after the incident? Yes No

⑭ What long-term monitoring / avoidance strategies were taken? _____

⑮ General comments _____

⑯ Master _____ Chief Engineer _____